

TM2 X SW



FAAC



SOMMARIO

COLLEGAMENTI ELETTRICI	3
CARATTERISTICHE TECNICHE	3
FUNZIONE LUX	4
TELECOMANDI COMPATIBILI	5
LEGENDA DEI SIMBOLI	5
SPIEGAZIONE DELLE SEQUENZE DI COMANDO	6
POSIZIONE DEL SENSORE	7
ASSOCIAZIONE DI PIÙ MOTORI AL SENSORE	7
FISSAGGIO DEL SENSORE	8
MEMORIZZAZIONE DEL SENSORE	9
CANCELLAZIONE DEL SENSORE	9
REGOLAZIONE DELLA FUNZIONE VENTO	10
ATTIVAZIONE DELLA RIAPERTURA AUTOMATICA	10
DISATTIVAZIONE DELLA RIAPERTURA AUTOMATICA	11
REGOLAZIONE DELLA FUNZIONE LUCE	11
ATTIVAZIONE DELLA MODALITÀ AUTOMATICA/MANUALE CON TELECOMANDO TM2 X TS	12
MODALITÀ TEST	13
DICHIARAZIONE DI CONFORMITÀ EU	14

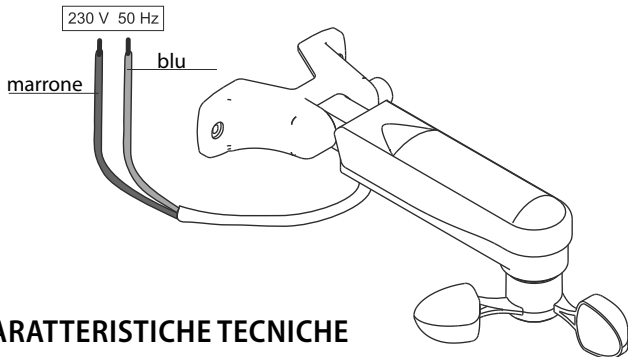
COLLEGAMENTI ELETTRICI



CARATTERISTICHE TECNICHE

	TM2 X SW		
Alimentazione (V) / (Hz)	230 / 50		
Frequenza radio (MHz)	433,92		
Regolazione sensore vento (km/h)	7,5 - 45		
Regolazione sensore luce (klux)	2,5 - 100		
Grado di protezione	IP33		
Dimensioni (mm)	300x140xH95		
Peso (g)	365		

In base al motore/centralina a cui il TM2 X SW è associato, la disponibilità di alcune funzioni cambia come indicato nella seguente tabella:

COMPATIBILITÀ	CHIUSURA CON ALLARME VENTO	RIAPERTURA AUTOMATICA	APERTURA E CHIUSURA CON LUCE	POSIZIONE INTERMEDIA AGGIUNTIVA	POSIZIONE "PRIVACY"
TM2 ERY	√	√	√	√	
TM2 X R Mini	√		√		

FUNZIONE LUX

IT **IMPORTANTE!** Per utilizzare la funzione luce nel modello "TM2 X SW" è necessario utilizzare un telecomando della serie TM2 X TS con la funzione LUX.

TM2 X TS-1

Attivazione funzione luce

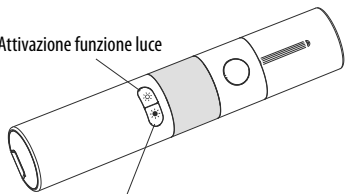

Disattivazione funzione luce

TM2 X TS-7

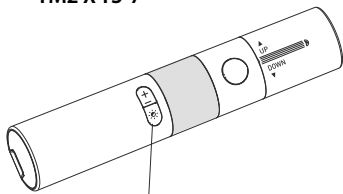

Attivazione/Disattivazione funzione luce



Sensore vento e sensore luce attivati



Solo sensore vento attivato

TELECOMANDI COMPATIBILI

TM2 X TT-50

Fare riferimento alle istruzioni specifiche del telecomando

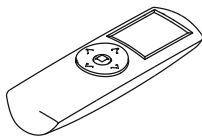

TM2 X T-1

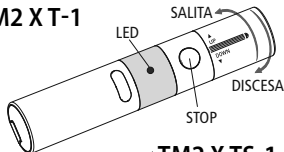

TM2 X TW-1

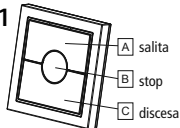

TM2 X T-7

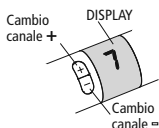

TM2 X TS-1

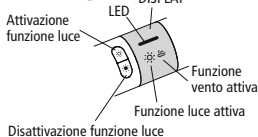

TM2 X TS-7

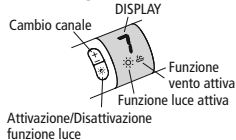

LEGENDA DEI SIMBOLI

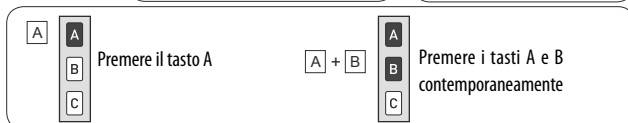
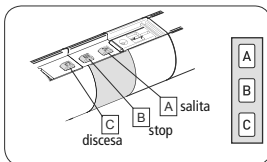
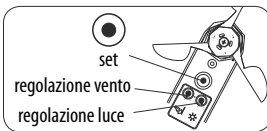
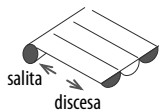

SPIEGAZIONE DELLE SEQUENZE DI COMANDO

La maggior parte delle sequenze di comando è composta da tre passi ben distinti, al termine dei quali il motore segnala, con diversi tipi di rotazione, se il passo si è concluso in modo positivo o negativo. Lo scopo di questo paragrafo è quello di riconoscere le segnalazioni del motore.

I tasti devono essere premuti come indicato nella sequenza, senza far passare più di 4 secondi tra un passo e l'altro. Se trascorrono più di 4 secondi, il comando non viene accettato, e si dovrà ripetere la sequenza.

Esempio di sequenza di comando:

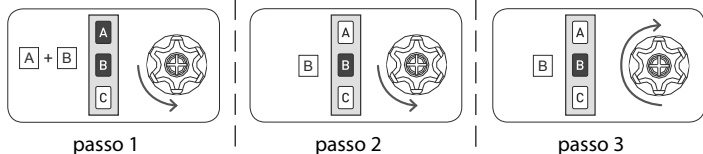

Come si vede nell'esempio, quando la sequenza termina in maniera positiva il motore si riporta nella posizione iniziale con una singola rotazione lunga. Infatti due brevi rotazioni nello stesso senso corrispondono ad una rotazione lunga nel senso opposto. Il motore si riporta nella posizione iniziale anche quando la sequenza non viene completata, in questo caso effettuando una o due brevi rotazioni.

Esempi di sequenze incomplete:

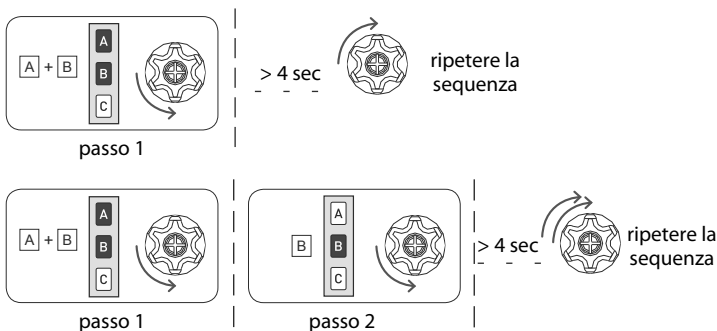

POSIZIONE DEL SENSORE

IMPORTANTE!

È indispensabile collocare il sensore TM2 X SW lateralmente, il più vicino possibile alla tenda associata, evitando di posizionarla nella zona superiore o inferiore, coperta dalla tenda.

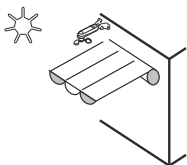

CORRETTO

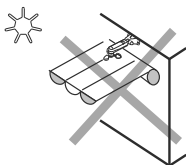

SBAGLIATO

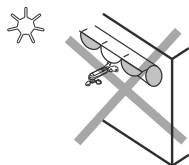

SBAGLIATO

ASSOCIAZIONE DI PIÙ MOTORI AL SENSORE

Una singolo sensore TM2 X SW può essere utilizzato per automatizzare un gruppo di tende motorizzate. Per un corretto funzionamento, è necessario che le tende da associare siano orientate nella stessa direzione di esposizione alla luce solare e al vento. Non è consigliato associare più di 5 tende alla stesso sensore.

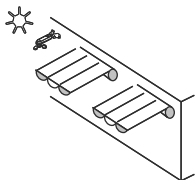

CORRETTO

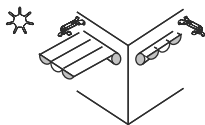

CORRETTO

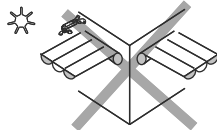

SBAGLIATO

FISSAGGIO DEL SENSORE

Il sensore TM2 X SW dispone di un meccanismo di posizionamento che ne permette il montaggio su qualsiasi superficie. Per regolare l'angolazione del supporto è necessario premere il pulsante posto in corrispondenza del perno di rotazione (vedi disegno).

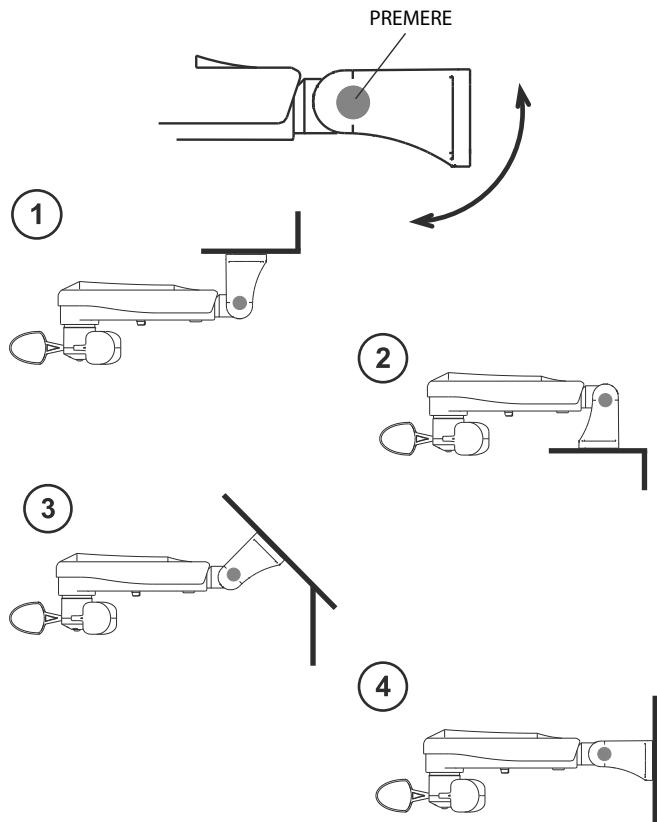

MEMORIZZAZIONE DEL SENSORE

Per realizzare l'associazione del sensore al motore, è necessario aver già memorizzato un telecomando nel motore. La sequenza di memorizzazione è la seguente:

Tn: Telecomando memorizzato

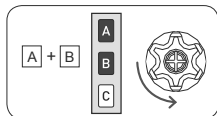

Tn

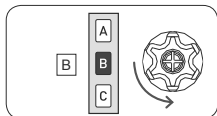

Tn



2 sec

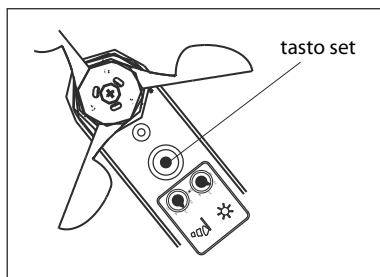

CANCELLAZIONE DEL SENSORE

Per cancellare l'associazione del sensore ad un motore, è necessario usare un telecomando memorizzato nel motore. La sequenza di cancellazione è la seguente:

Tn: Telecomando memorizzato

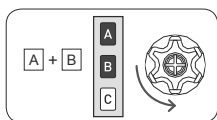

Tn

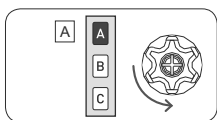

Tn



2 sec

REGOLAZIONE DELLA FUNZIONE VENTO

La regolazione della soglia del vento si effettua con l'apposita manopola, situata nella parte inferiore del sensore TM2 X SW, identificata con il simbolo della manica a vento. La regolazione può essere impostata da una velocità minima di 7,5 km/h, fino a una velocità massima di 45 km/h.



Come illustrato nel disegno, è prudente non impostare la soglia oltre il numero 4, che corrisponde a circa 35 km/h.

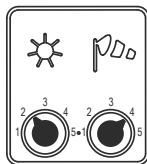
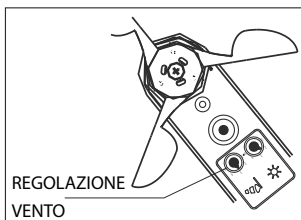

In seguito all'allarme vento, il motore comanderà l'avvolgimento della tenda, fino alla posizione di chiusura, bloccandone il comando da parte dell'utente, fino alla fine dell'allarme vento. Per la disattivazione dell'allarme vento, è necessario che la velocità del vento rimanga sotto la soglia impostata, per almeno 8 minuti. Se è stata attivata la funzione di Riapertura Automatica, passati questi 8 minuti il motore comanderà l'apertura della tenda, fino alla posizione in cui si trovava prima dell'allarme. Questo tempo di attesa è stato inserito per assicurare la protezione della tenda e per evitare che il motore sia in continuo movimento, in caso di sporadiche raffiche di vento.

ATTIVAZIONE DELLA RIAPERTURA AUTOMATICA

- solo con motori TM2 ERY -

Con il sistema di riapertura automatica la tenda si riapre appena termina l'allarme vento.

Il motore è programmato in fabbrica con la funzione di riapertura automatica disattivata. La funzione può essere attivata in qualsiasi momento con la seguente sequenza di comando:

Tn: Telecomando memorizzato

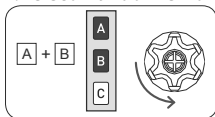

Tn

TM2 X SW

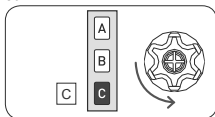

Tn

10

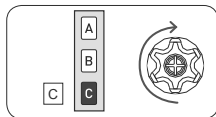

Tn (2 sec)

A4518_6H80_Rev.A

DISATTIVAZIONE DELLA RIAPERTURA AUTOMATICA

- solo con motori TM2 ERY -

La funzione di riapertura può essere disattivata con la seguente sequenza di comando.

Tn: Telecomando memorizzato

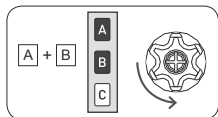

Tn

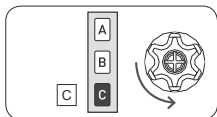

Tn

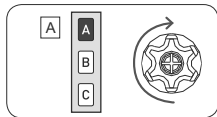

Tn (2 sec)

REGOLAZIONE DELLA FUNZIONE LUCE

La regolazione della soglia della luce si effettua con l'apposita manopola, situata nella parte inferiore del sensore TM2 X SW, identificata con il simbolo del sole.



La regolazione può essere impostata da una intensità minima di 2,5 kLux (luce ambiente all'alba), fino a una intensità massima di 100 kLux (luce solare a mezzogiorno). Per attivare l'apertura automatica della tenda, è necessario che l'intensità della luce superi la soglia impostata per 1 minuto, mentre per attivare la chiusura automatica, l'intensità della luce deve rimanere al di sotto della soglia impostata per almeno 10 minuti. Questi tempi di attesa sono stati inseriti per evitare che il motore sia in continuo movimento, in caso di nuvole passeggere. L'apertura e la chiusura automatica funzionano solo quando il motore è impostato nella modalità automatica vento + luce.

ATTIVAZIONE DELLA MODALITÀ AUTOMATICA/MANUALE CON TELECOMANDO TM2 X TS

Per impostare la modalità manuale (solo vento), o quella automatica (vento + luce), è necessario il telecomando TM2 X TS-1 o TM2 X TS-7.

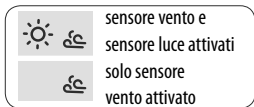

Utilizzando i tasti sul fronte del telecomando eseguire quanto segue:

TM2 X TS-1

Premendo brevemente uno dei due tasti, il display mostra l'impostazione attuale.



Per cambiare l'impostazione, è necessario premere per almeno 3 secondi il tasto corrispondente alla funzione desiderata, fino a che il motore risponde con una sequenza di conferma.

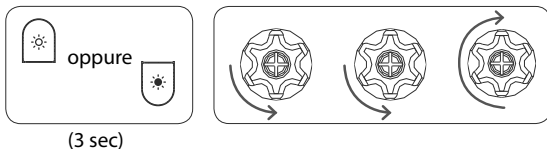

TM2 X TS-7

Premendo brevemente il tasto, il display mostra l'impostazione attuale.

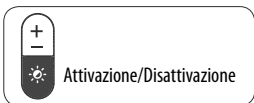

Per cambiare l'impostazione, è necessario ripremere il tasto per almeno 3 secondi, fino a che il motore risponde con una sequenza di conferma.

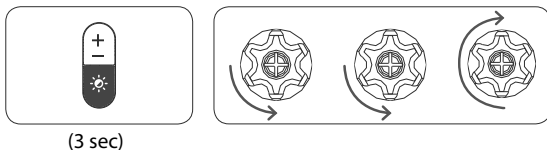

MODALITÀ TEST

Questa funzione è utile per verificare la corretta comunicazione via radio e per effettuare la prova delle funzioni vento e luce.

Per attivare la funzione di TEST, tenere premuto il tasto SET (circa 2 sec), finché il motore confermerà il comando, portando la tenda a metà della corsa di apertura. La funzione di test sarà attiva per 3 minuti, durante i quali sarà possibile verificare l'impostazione delle soglie vento e luce, senza che sia necessario attendere i tempi di attivazione. Dopo 3 minuti, il sensore TM2 X SW ritornerà a funzionare in modo normale.

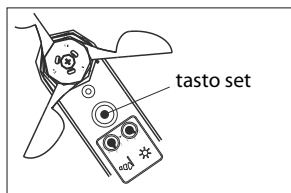

(2 sec)

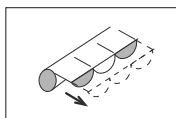

PROVA DELLA FUNZIONE VENTO

Per evitare errori durante la prova della funzione vento, si raccomanda di impostare il motore in modalità manuale (solo vento). Facendo muovere le pale dell'anemometro, quando la velocità rilevata dal sensore supera la soglia impostata, il motore comanderà l'avvolgimento completo della tenda. Dopo che la tenda è stata avvolta, fermando le pale dell'anemometro, la tenda ritorna a metà corsa, se la funzione di riapertura automatica è attiva. Se la funzione di riapertura automatica non è attiva, la tenda rimane chiusa.

PROVA DELLA FUNZIONE LUCE

Assicurarsi che il motore sia impostato in modalità automatica. Quando il sensore rileva una variazione dell'intensità della luce, aprirà la tenda se l'intensità della luce va al di sopra della soglia impostata, oppure chiuderà la tenda se l'intensità della luce va al di sotto della soglia impostata. È possibile ripetere più volte questo test, per stabilire la regolazione della soglia desiderata per l'apertura e la chiusura automatica in base all'intensità della luce.

DICHIARAZIONE DI CONFORMITÀ EU

Il fabbricante, FAAC S.p.A. Soc. Unipersonale, dichiara che il tipo di apparecchiatura radio marca FAAC modello TM2 X SW è conforme alle pertinenti normative di armonizzazione dell'Unione: Direttiva 2014/53/EU, Direttiva 2011/65/EU.

Il testo completo della dichiarazione di conformità EU è disponibile al seguente indirizzo Internet: **<http://www.faac.biz/certificates>**

Bologna, 18-09-2018

CEO A. Marcellan



CONTENTS



ELECTRICAL CONNECTIONS	16
TECHNICAL FEATURES	16
LUX FUNCTION	17
COMPATIBLE REMOTE CONTROLS	18
KEY TO SYMBOLS	18
COMMAND SEQUENCES EXAMPLE	19
WHERE TO PLACE THE WIND & SUN SENSOR	20
SETTING OF SEVERAL MOTORS TO ONE SENSOR	20
FITTING THE WIND & SUN SENSOR	21
SETTING THE WIND & SUN SENSOR	22
DELETING THE WIND & SUN SENSOR	22
SETTING THE WIND SENSOR	23
ACTIVATING AUTOMATIC REOPENING	23
DEACTIVATING AUTOMATIC REOPENING	24
SETTING THE SUN SENSOR	24
ACTIVATING THE AUTOMATIC OR MANUAL SETTING MODE BY THE REMOTE	
CONTROL SERIES TM2 X TS	25
TEST MODE	26
EU DECLARATION OF CONFORMITY	27

ELECTRICAL CONNECTIONS

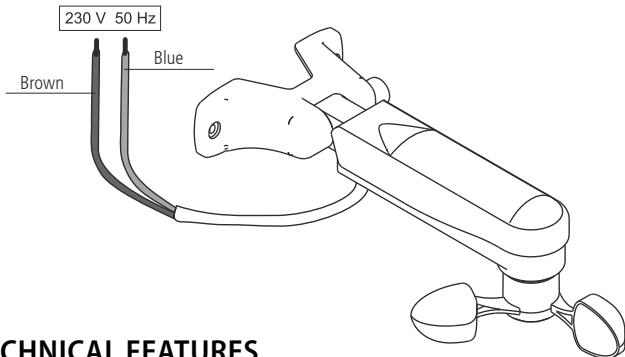
EN



TECHNICAL FEATURES

	TM2 X SW	 
Power supply (V) / (Hz)	230 / 50	
Radio frequency (MHz)	433,92	
Setting Wind sensor (km/h)	7,5 - 45	
Setting Sun sensor (klux)	2,5 - 100	
Degree of protection	IP33	
Dimensions (mm)	300x140xH95	
Weight (g)	365	

According to the motor / control unit to which the TM2 X SW is associated, the availability of certain features changes as indicated in the following table:

COMPATIBILITY	CLOSING BY WIND ALARM	AUTOMATIC REOPENING	OPENING AND CLOSING WITH LIGHT	ADDITIONAL MIDDLE POSITION	"PRIVACY" POSITION
TM2 ERY	✓	✓	✓	✓	
TM2 X R Mini	✓		✓		

LUX FUNCTION

ATTENTION! The light function in model TM2 X SW can be activated only by using a remote control series TM2 X TS with the LUX function.

EN

TM2 X TS-1

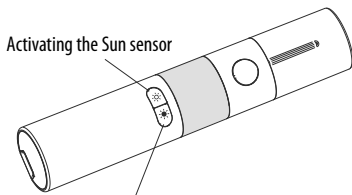

TM2 X TS-7

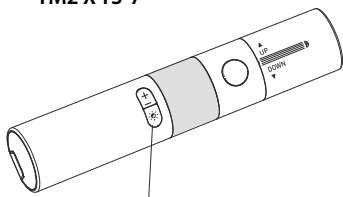

Wind & Sun sensor activate.



Only Wind sensor activate.

COMPATIBLE REMOTE CONTROLS

TM2 X TT-50

Check the specific instruction book

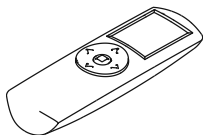

TM2 X T-1

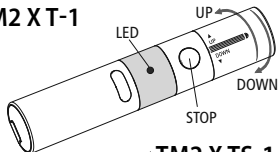

TM2 X TW-1

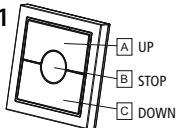

TM2 X T-7

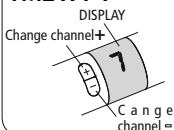

TM2 X TS-1

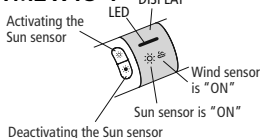

TM2 X TS-7

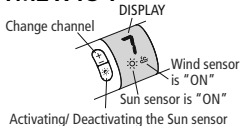

KEY TO SYMBOLS

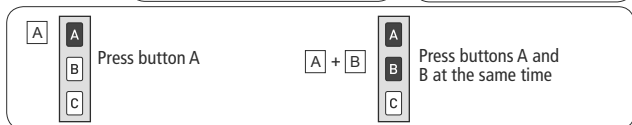
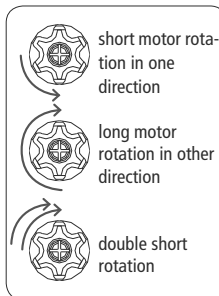
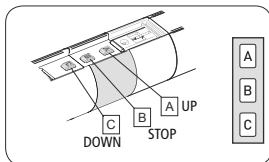
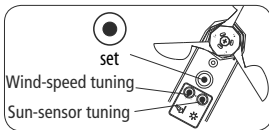
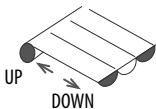

COMMAND SEQUENCES EXAMPLE

Most of the command sequences have three distinct steps, at the end of which the motor indicates if the step has been concluded positively or not, by turning in different ways. This section is provided to demonstrate the motor indications. The buttons must be pressed as shown in the sequence, without taking more than 4 seconds between one step and the next. If more than 4 seconds are taken, the command is not accepted and the sequence must be repeated.

Command sequence example:

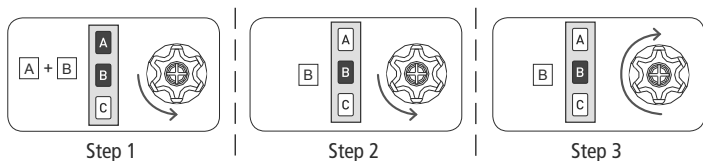

As we can see from the example, when the sequence ends positively, the motor returns to its starting position in one long rotation. In fact, two short rotations in the same direction correspond to one long rotation in the opposite direction. The motor returns to the starting position even when the sequence is not completed; in this case by performing one or two short rotations.

Example of a wrong sequence:

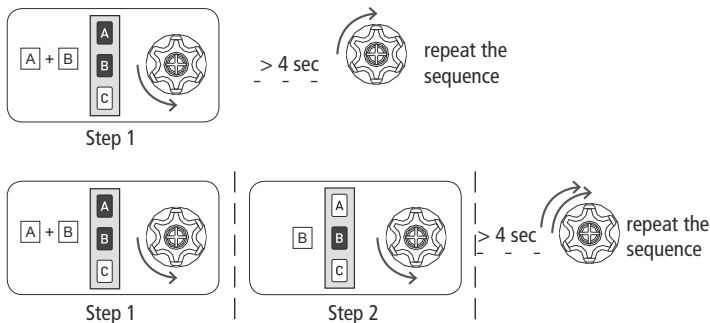

WHERE TO PLACE THE WIND & SUN SENSOR

ATTENTION!

The TM2 X SW sensor must be positioned to the side, as close as possible to its awning, and not above or below the awning coverage area.

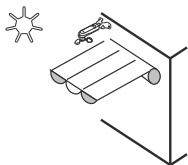

RIGHT

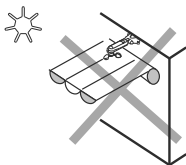

WRONG

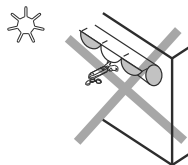

WRONG

SETTING OF SEVERAL MOTORS TO ONE SENSOR

One single TM2 X SW sensor can be used to automate a group of motorised awnings. For a correct function, the coupled awnings must be mounted and exposed to sunlight and wind in the same way. Do not connect more than 5 motors to one wind sensor.

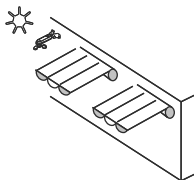

RIGHT

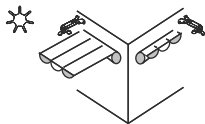

RIGHT

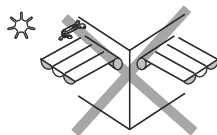

WRONG

FITTING THE WIND & SUN SENSOR

The TM2 X SW sensor has a positioning mechanism for fitting to any surface. To adjust fitting-angle, press the button to rotate the support (see drawing).

EN

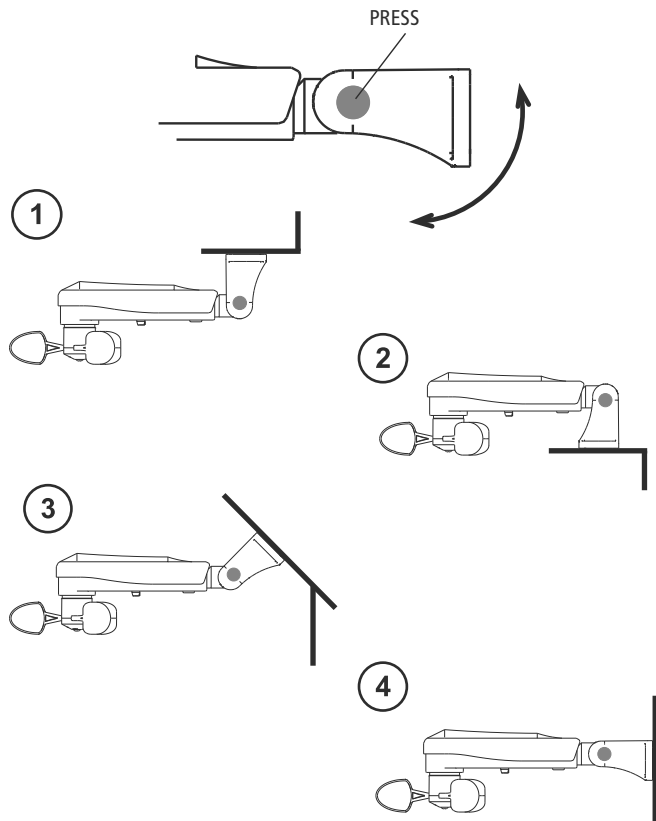

SETTING THE WIND & SUN SENSOR

To associate TM2 X SW sensor to a motor, a remote control must be already memo-
rised on the motor. The setting sequence is the following:

Tn: Already programmed remote control

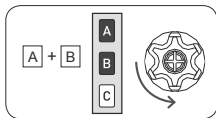

Tn

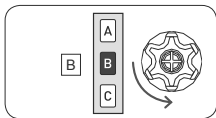

Tn



2 sec

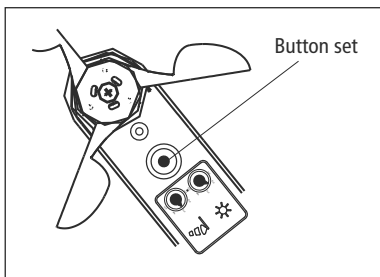

DELETING THE WIND & SUN SENSOR

To delete the TM2 X SW sensor from the motor, an already programmed remote
control must be used. The deleting sequence is the following:

Tn: Already programmed remote control

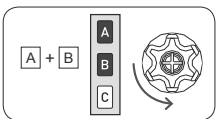

Tn

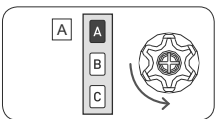

Tn



2 sec

SETTING THE WIND SENSOR

The wind level point can be set using the button provided in the lower part of the TM2 X SW sensor, identified by the windsock symbol. The speed can be set from a minimum of 7,5 Km/h to a maximum of 45 Km/h.

 It's prudent not to set the wind speed over the fourth level, which corresponds to 35 Km/h.

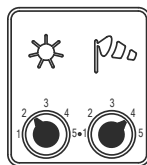
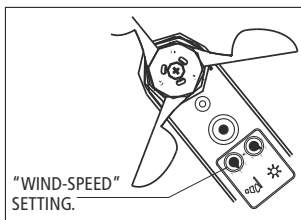

MAXIMUM RECOMMENDED SPEED
FOR THE WIND-ALARM (35 km/h)

Following a wind alarm, the motor closes automatically the awning, overriding user commands until the wind alarm passes. To deactivate the wind alarm, it's necessary that the wind speed remains below the set level for at least 8 minutes. After these 8 minutes the awning returns to the position it was in before the alarm, if the automatic reopening function is active. This pause time is included to ensure awning protection and to prevent continuous motor movement in the event of sporadic gusts of wind.

ACTIVATING AUTOMATIC REOPENING

- only with TM2 ERY -

With the automatic reopening system, at the end of the wind alarm, the awning opens again. From factory this function is not activated in the motor, but can be easily activated with the following command sequence:

Tn: Already programmed remote control

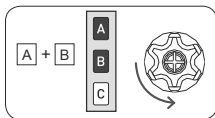

Tn

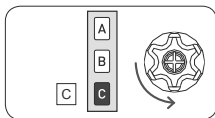

Tn

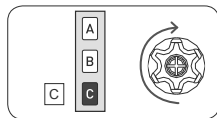

Tn (2 sec)

DEACTIVATING AUTOMATIC REOPENING

- only with TM2 ERY -

EN

The automatic reopening function can be deactivated at any moment with the following command sequence:

Tn: Already programmed remote control

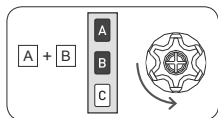

Tn

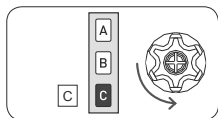

Tn

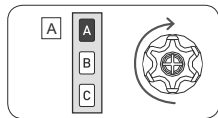

Tn (2 sec)

SETTING THE SUN SENSOR

The light level point can be set using the button provided in the lower part of the TM2 X SW sensor, identified by the sun symbol.



The light intensity can be set from a minimum of 2.5 kLux (dawn light) up to a maximum of 100 kLux (midday sunlight). To activate the automatic awning opening, the light intensity must exceed the set level for 1 minute, while for automatic closing, the light intensity must remain below the set level for at least 10 minutes. These pause times are included to prevent the motor from moving continuously in the event of passing clouds. Automatic opening and closing only work when the motor is set to the automatic wind + light mode.

ACTIVATING THE AUTOMATIC OR MANUAL SETTING MODE BY THE REMOTE CONTROL SERIES TM2 X TS

The manual mode (wind only), or automatic mode (wind + sun) setting has to be done by the TM2 X TS-1 or TM2 X TS-7 remote control.



Wind & Sun sensor activate.



Only Wind sensor activate.

EN

Using the front buttons on the remote control do the following:

TM2 X TS-1

By pressing briefly one button the display will show the current setting.



Activating

Deactivating

To change setting, press for at least 3 seconds the button related to the desired function, till the motor feedback.

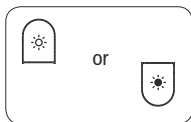

(3 sec)

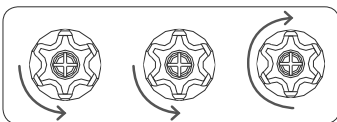

TM2 X TS-7

By pressing briefly the button the display will show the current setting.



Activating/ Deactivating

To change setting press the same button for at least 3 seconds till the motor feedback.

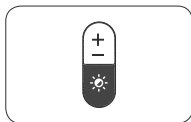

(3 sec)

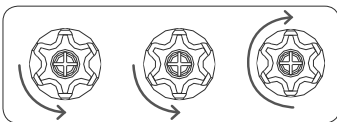

TEST MODE

This function is useful to check the correct communication via radio, and to perform the wind and sun function test.

To activate the TEST function, hold the SET button down for around 2 seconds, until the motor confirms the command by bringing the awning to half opening distance. The test function lasts for 3 minutes, during which the wind and light level settings can be checked, without waiting for the activation times. After 3 minutes, the TM2 X SW sensor returns to normal mode function.

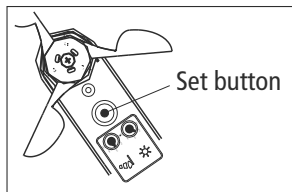

(2 sec)

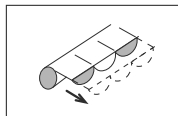

WIND FUNCTION TEST

To avoid errors during the wind function test, we advise setting the motor to manual mode (wind only). With the anemometer blades moving, when the speed detected by the sensor exceeds the set level, the motor will close completely the awning. After the awning is closed and the anemometer blades stop turning, the awning returns to halfway out if the automatic reopening function is active; if it is not, the awning remains closed.

SUN FUNCTION TEST

Check that the motor is set to the automatic mode. When the sensor detects a change in light intensity, it opens the awning if brighter than the set point or closes it if weaker. This test can be repeated several times to establish the desired automatic opening and closing level according to the light.

EU DECLARATION OF CONFORMITY

The manufacturer, FAAC S.p.A. Soc. Unipersonale, hereby, declares that the FAAC model TM2 X SW radio equipment is in compliance with Directive 2014/53/EU, Directive 2011/65/EU.

The full text of the EU declaration of conformity is available at the following Internet address: **<http://www.faac.biz/certificates>**.

Bologna, 18-09-2018

CEO A. Marcellan



INHALTSVERZEICHNIS

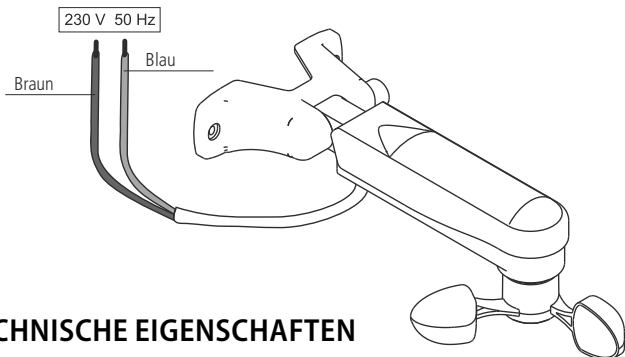

ELEKTRISCHE ANSCHLÜSSE	29
TECHNISCHE EIGENSCHAFTEN	29
FUNKTION LUX	30
KOMPATIBLE HANDSENDER	31
SYMBOLERKLÄRUNG	31
EINGABE DER BEFEHLSFOLGEN	32
POSITIONIERUNG DER WETTERSTATION	33
ANSCHLUSS MEHRERER MOTOREN AN DIE WETTERSTATION	33
BEFESTIGUNG DER WETTERSTATION	34
EINPROGRAMMIERUNG DER WETTERSTATION	35
LÖSCHUNG DER WETTERSTATION	35
EINSTELLUNG DES WINDWÄCHTERS	36
AKTIVIERUNG DER AUTOMATISCHEN ÖFFNUNG NACH EINEM WINDALARM	36
DEAKTIVIERUNG DER AUTOMATISCHEN ÖFFNUNG NACH EINEM WINDALARM	37
EINSTELLUNG DES SONNENSENSORS	37
AKTIVIEREN / DEAKTIVIEREN DES SONNENSENSORS MIT HANDSENDER DER BAUREIHE TM2 X TS	38
TEST MODUS	39
EU-KONFORMITÄTSERKLÄRUNG	40

ELEKTRISCHE ANSCHLÜSSE



DE

TECHNISCHE EIGENSCHAFTEN

	TM2 X SW	 
Spannung (V) / (Hz)	230 / 50	
Funkfrequenz (MHz)	433,92	
Einstellung Windsensor (km/h)	7,5 - 45	
Einstellung Sonnensensor (klux)	2,5 - 100	
Schutzgrad	IP33	
Dimensionen (mm)	300x140xH95	
Gewicht (g)	365	

Entsprechend der Verwendung des TM2 X SW, mit Motor oder Funkempfänger, ändert sich die Verfügbarkeit einiger Funktionen wie folgend beschrieben:

KOMPATIBILITÄT	SCHLIEßEN DURCH WINDALARM	AUTOMATISCHE ÖFFNUNG	ÖFFNEN UND SCHLIEßEN MIT LICHT	ZUSÄTZLICHE MITTEL POSITION	PRIVACY-POSITION
TM2 ERY	✓	✓	✓	✓	
TM2 X R Mini	✓		✓		

FUNKTION LUX

ACHTUNG! Zur Funktion des Sonnensensor beim "TM2 X SW" muss ein Handsender der Baureihe TM2 X TS mit der "LUX" Funktion verwendet werden.

DE

TM2 X TS-1

Sonnensensor
Aktivieren

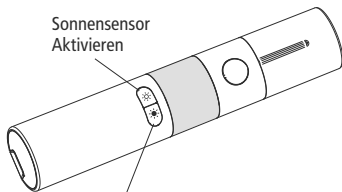

Sonnensensor
Deaktivieren

TM2 X TS-7

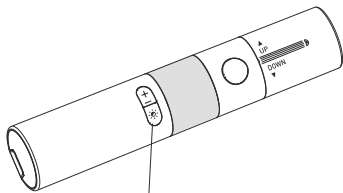

Aktivieren / Deaktivieren
des Sonnensensors



Windwächter und Sonnensensor aktiv.



Nur Windwächter aktiv.

KOMPATIBLE HANDSENDER

DE

TM2 X TT-50

Siehe die entsprechende Bedienungsanleitung

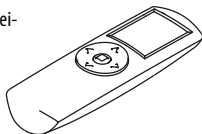

TM2 X T-1

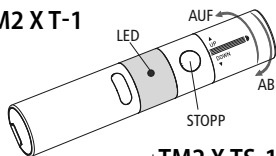

TM2 X TW-1

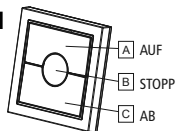

TM2 X T-7

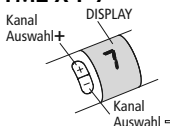

TM2 X TS-1

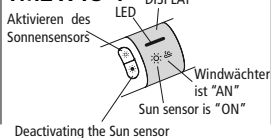

TM2 X TS-7

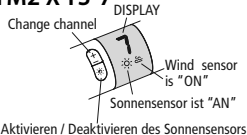

SYMBOLERKLÄRUNG

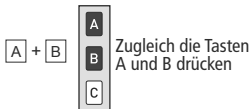
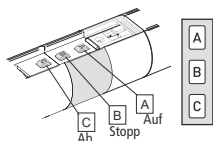
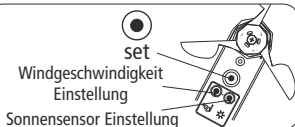
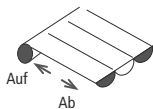

EINGABE DER BEFEHLSFOLGEN

Die meisten Befehlsfolgen entsprechen drei klar unterschiedlichen Schritten, bei deren Ende der Motor, mit unterschiedlichen Drehungen, anzeigt ob die Eingabe erfolgreich war oder misslungen ist. Hier werden die vom Motor gegebenen Signale erläutert.

Die Tasten müssen wie unten beschrieben gedrückt werden und es dürfen nicht mehr als 4 Sekunden von einem Schritt zum anderen verstreichen. Sollten mehr als 4 Sekunden verstreichen, wird die Befehlsfolge nicht akzeptiert und man muss diese wiederholen.

Beispiel einer Befehlsfolge:

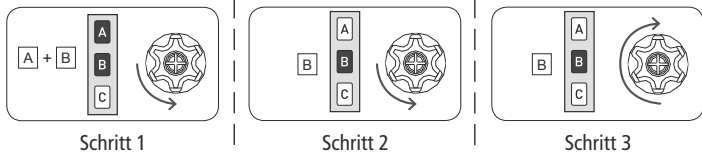

Bei positiv abgeschlossener Befehlsfolge, wie auf obigem Beispiel dargestellt, kehrt der Motor nach zwei kurzen Drehungen, mit einer langen Drehung wieder auf die Startposition zurück. Zwei kurze Drehungen in eine Richtung entsprechen der langen Drehung in die entgegengesetzte Richtung. Bei unvollständiger Befehlsfolge kehrt der Motor, nach 1 oder 2 kurzen Drehungen, in die Startposition zurück.

Beispiel einer unvollständigen Befehlsfolge:

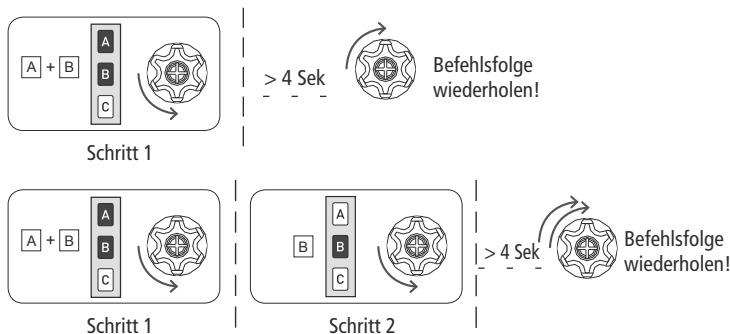

POSITIONIERUNG DER WETTERSTATION

VORSICHT!

Die Wetterstation TM2 X SW ist seitlich, so nahe wie möglich an der entsprechenden Markise zu montieren. Diese darf weder unterhalb oder oberhalb, noch von der Markise verdeckt montiert werden.

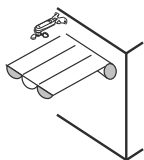

RICHTIG

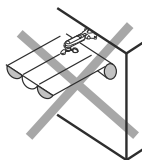

FALSCH

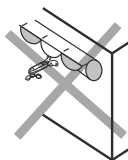

FALSCH

DE

ANSCHLUSS MEHRERER MOTOREN AN DIE WETTERSTATION

Mit einer einzelnen Wetterstation TM2 X SW können bis zu 5 Markisen, die mit Rohrmotoren TM2 ERY bestückt sind, gesteuert werden. Um eine korrekte Funktion zu gewährleisten müssen die Markisen in derselben Richtung montiert werden und diese den Licht- und Windquellen gleichermaßen ausgesetzt sein.

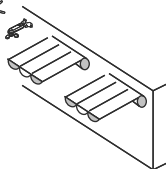

RICHTIG

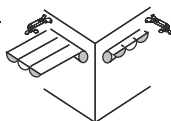

RICHTIG

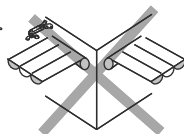

FALSCH

BEFESTIGUNG DER WETTERSTATION

Die Wetterstation TM2 X SW beinhaltet einen Verstellmechanismus der die Montage in diversen Positionen erlaubt. Die Verstellung der Neigung des Halters kann durch drücken des "Knopfes" ausgeführt werden. Bei Druck löst sich die Einrastung und ermöglicht die Verstellung.

DE

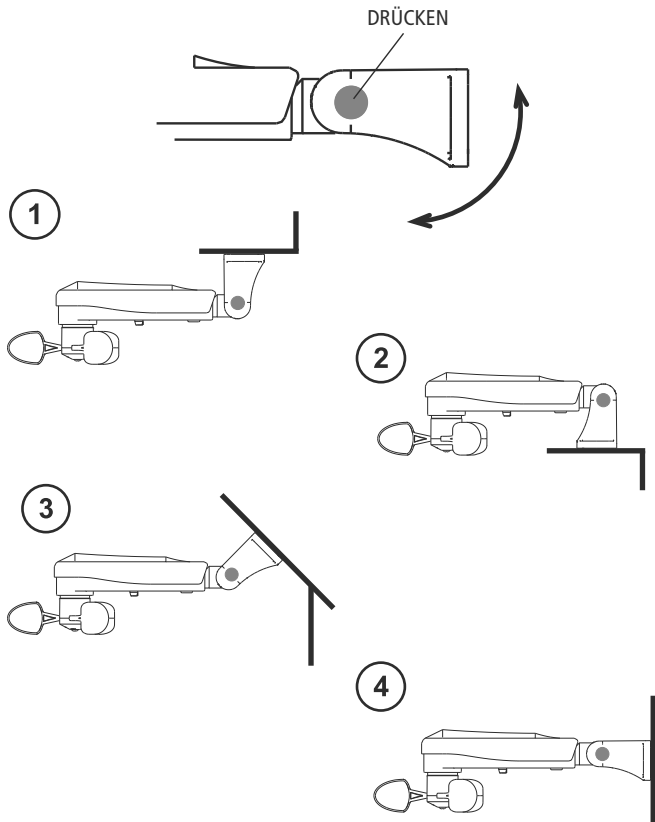

EINPROGRAMMIERUNG DER WETTERSTATION

Um die Wetterstation mit dem Motor in Verbindung zu bringen, muss ein bereits eingestellter Handsender benutzt werden. Zur Einstellung geht man wie folgt vor:

Tn: Eingestellter Handsender

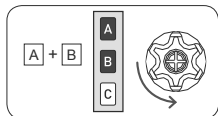

Tn

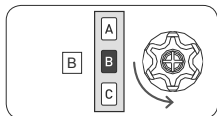

Tn



2 Sek

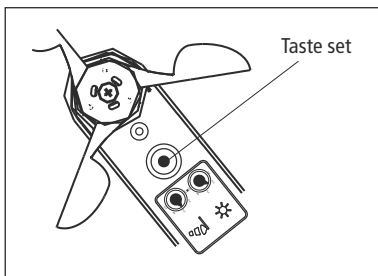

LÖSCHUNG DER WETTERSTATION

Zur Löschung der Verbindung der Wetterstation zum Motor, muss ein bereits eingestellter

Handsender benutzt werden. Zur Löschung geht man wie folgt vor:

Tn: Eingestellter Handsender

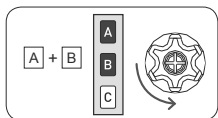

Tn

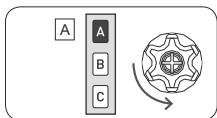

Tn



2 Sek

EINSTELLUNG DES WINDWÄCHTERS

Die Einstellung der Wind-Alarmauslösung erfolgt über das unten am Gehäuse befindliche, mit dem Symbol der Windrose versehene, Einstellrad der Wetterstation TM2 X SW. Der "Windalarm" kann auf drei verschiedene Niveaus, von minimal 7,5 Km/h bis maximal 45 km/h, eingestellt werden.



Es ist ratsam den Windalarm nicht über das vierte Niveau, von 35 Km/h, einzustellen.

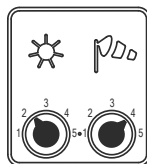
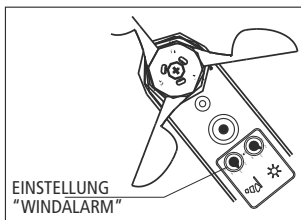

MAXIMAL EMPFOHLENES NIVEAU FÜR DEN WINDALARM (35Km/h)

Bei Auslösung des Windalarms, gibt die Elektronik des Motors den "Schließbefehl", wobei die Markise ganz geschlossen wird. Jeder weitere Befehl, des Benutzers, bleibt bis Ende des Windalarms blockiert. Die Deaktivierung des Windalarms tritt ein wenn das eingestellte Alarmniveau während mindestens 8 Minuten nicht mehr erreicht wird. Danach fährt die Markise bei aktivierter automatischen Öffnung wieder auf die Position vor dem Windalarm. Um die Markise zu schonen, und um zu verhindern dass der Motor bei geringen Windstößen zu oft in Bewegung ist, wurde diese Wartezeit bewusst einprogrammiert.

AKTIVIERUNG DER AUTOMATISCHEN ÖFFNUNG NACH EINEM WINDALARM

- nur mit Motoren TM2 ERY -

Mit der automatischen Öffnung nach dem Windalarm öffnet sich die Markise, nach dem Windalarm, wieder. Ab Werk ist diese Funktion beim Motor deaktiviert und kann ganz einfach, mit der folgenden Prozedur, aktiviert werden:

Tn: Eingestellter Handsender

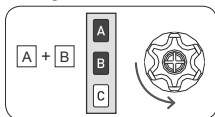

Tn

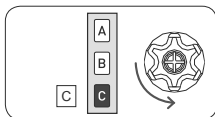

Tn

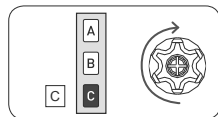

Tn (2 Sek)

DEAKTIVIERUNG DER AUTOMATISCHEN ÖFFNUNG NACH EINEM WINDALARM

- nur mit Motoren TM2 ERY -

Nach einer Aktivierung kann die automatische Öffnung nach einem Windalarm mit den folgend beschriebenen Befehlsfolgen erneut deaktiviert werden:

Tn: Eingestellter Handsender

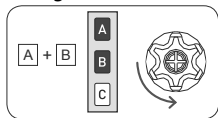

Tn

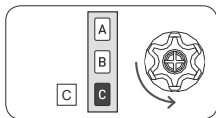

Tn

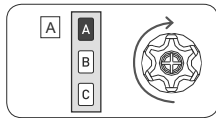

Tn (2 Sek)

EINSTELLUNG DES SONNENSENSORS

Die Einstellung des Niveaus des Sonnen-Alarmauslösung erfolgt über das unten am Gehäuse befindliche, mit dem Symbol der Sonne versehene, Einstellrad der Wetterstation TM2 X SW.



Die Einstellung kann von minimal 2,5 kLux (Licht bei Sonnenaufgang) bis zu einem maximalen Niveau von 100 kLux (Lichtverhältnisse Mittagssonne) getätigt werden. Die Aktivierung der automatischen Öffnung der Markise setzt voraus, dass das voreingestellte Niveau während mindestens einer Minute übertroffen wird. Zur automatischen Schließung muss das voreingestellte Niveau für mindestens 10 Minuten nicht mehr erreicht werden. Um die Markise zu schonen, und um zu verhindern dass der Motor bei vorbeiziehenden Wolken stets in Bewegung ist, wurde diese Wartezeit bewusst einprogrammiert. Die Funktion des "Sonnenalarms" kann auch deaktiviert werden.

AKTIVIEREN / DEAKTIVIEREN DES SONNENSSENSORS MIT HANDSENDER DER BAUREIHE TM2 X TS

Um den Sonnensensor zu deaktivieren oder zu aktivieren (Windwächter & Sonnensensor aktiv), muss ein Handsender TM2 X TS-1 oder TM2 X TS-7 verwendet werden.



Windwächter und
Sonnensensor aktiv.



Nur Windwächter
aktiv.

Mit den folgend abgebildeten Tasten wie folgend beschrieben vorgehen:

TM2 X TS-1

Bei kurzem antippen der Taste wird der bestehende Status gezeigt.



Aktivieren



Deaktivieren

Um den Sonnensensor zu aktivieren oder deaktivieren, die entsprechende Taste mindestens 3 Sekunden lang gedrückt halten, bis der Motor mit der hier abgebildeten Rotationsfolge die Eingabe bestätigt.

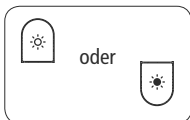

(3 Sek)

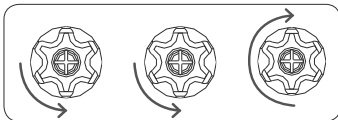

TM2 X TS-7

Bei kurzem antippen der Taste wird der bestehende Status gezeigt.



Aktivieren / Deaktivieren

Um den Sonnensensor zu aktivieren oder deaktivieren, die entsprechende Taste mindestens 3 Sekunden lang gedrückt halten, bis der Motor mit der hier abgebildeten Rotationsfolge die Eingabe bestätigt.

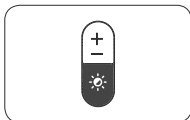

(3 Sek)

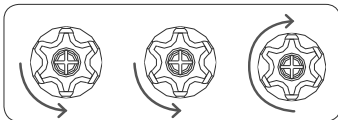

TEST MODUS

Mit diesem Test Modus kann die Funkverbindung geprüft werden, und zugleich die Windwächter und Sonnensensor Funktion getestet werden.

Zur Aktivierung der Testfunktion die Taste SET ca. 2 lang drücken bis der Motor den Befehl bestätigt und die Markise auf ca. die Hälfte des "Ab" Laufes bringt. Die Testfunktion bleibt für 3 Minuten aktiv, während dessen es möglich sein wird die Wind+Sonne Niveau Einstellungen zu prüfen. Nach 3 Minuten erlischt der Testmodus und die Wetterstation TM2 X SW kehrt in die normale Funktionstätigkeit zurück.

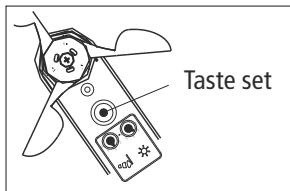

(2 Sek)

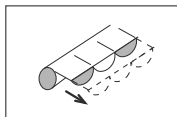

FUNKTIONSTEST DES WINDWÄCHTERS

Zur Fehlervermeidung während der Testfase, muss der Motor zuerst auf die manuelle Funktion (nur Wind) programmiert werden. Wird bei Betätigung der Schaufeln des Windwächters, das voreingestellte Niveau übertroffen, gibt der Motor den "Schließbefehl". Nach der Aufwicklung der Markise und sogleich folgendem stoppen der Schaufeln des Windwächters, fährt die Markise bei aktivierter automatischen Öffnung auf die Hälfte des "Ab" Laufes hinunter. Sollte hierbei die automatische Öffnung deaktiviert sein, bleibt die Markise geschlossen.

FUNKTIONSTEST DES SONNENSENSORS

Sichern Sie ab, dass der Motor auf die automatische Funktion programmiert ist. Bemerkt der Sensor nun eine Veränderung der Lichtverhältnisse, wird die Markise geschlossen im Falle der Wert über das eingegebene Niveau steigt, oder geöffnet wenn der Wert unter das eingegebene Niveau fällt. Zur Erzielung der Auf und Ab Befehle zu den gewünschten Lichtverhältnissen, kann dieser Test mehrmals durchgeführt werden.

EU-KONFORMITÄTSERKLÄRUNG

Der Hersteller FAAC S.p.A. Soc. Unipersonale erklärt hiermit, dass die FAAC Fun-
kanlage des Typs TM2 X SW der Richtlinie 2014/53/EU, 2011/65/EU entspricht.
Der vollständige Text der EU-Konformitätserklärung ist unter der folgenden
Internetadresse verfügbar: <http://www.faac.biz/certificates>.

Bologna, 18-09-2018

CEO A. Marcellan



SOMMAIRE

CONNEXIONS ÉLECTRIQUES	42
CARACTÉRISTIQUES TECHNIQUES	42
FONCTION LUX	43
ÉMETTEURS COMPATIBLES	44
LÉGENDE DES SYMBOLES	44
EXPLICATION DES SÉQUENCES DE COMMANDE	45
MISE EN PLACE DU CAPTEUR	46
ASSOCIATION DE PLUSIEURS MOTEURS AU CAPTEUR	46
FIXATION DU CAPTEUR	47
MÉMORISATION DU CAPTEUR	48
ANNULATION DU CAPTEUR	48
RÉGLAGE DE LA FONCTION DU VENT	49
ACTIVATION DE LA RÉOUVERTURE AUTOMATIQUE	49
DÉSACTIVATION DE LA RÉOUVERTURE AUTOMATIQUE	50
RÉGLAGE DE LA FONCTION LUMIÈRE	50
ACTIVATION DU MODE AUTOMATIQUE/MANUEL AVEC LES ÉMETTEURS SÉRIE TM2 X TS	51
MODE DE TEST	52
DÉCLARATION DE CONFORMITÉ UE	53

CONNEXIONS ÉLECTRIQUES

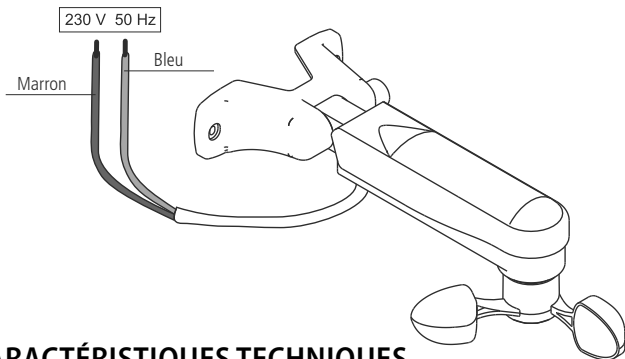

CARACTÉRISTIQUES TECHNIQUES

	TM2 X SW 
Alimentation (V) / (Hz)	230 / 50
Fréquence radio (MHz)	433,92
Réglage du détecteur de vent (km/h)	7,5 - 45
Réglage du détecteur de lumière (klux)	2,5 - 100
Indice de protection	IP33
Dimensions (mm)	300x140xH95
Poids (g)	365

La disponibilité de certaines fonctions change selon le moteur/récepteur auquel le TM2 X SW est associé. Voir le tableau qui suit:

COMPATIBILITÉ	FERMETURE PAR ALARME DE VENT	RÉOUVERTURE AUTOMATIQUE	OUVERTURE ET FERMETURE AVEC LUMIÈRE	POSITION INTERMÉDIAIRE SUPPLÉMENTAIRE	POSITION "PRIVACY"
TM2 ERY	√	√	√	√	
TM2 X R Mini	√		√		

FONCTION LUX

TRÈS IMPORTANT! Pour utiliser la fonction solaire du modèle "TM2 X SW", il est nécessaire d'utiliser un émetteur de la série TM2 X TS avec la fonction LUX.

TM2 X TS-1

Activation de la fonction solaire

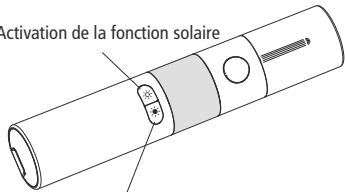

Désactivation de la fonction solaire

 Active le capteur de vent et de lumière

 Active le capteur de vent seulement

TM2 X TS-7

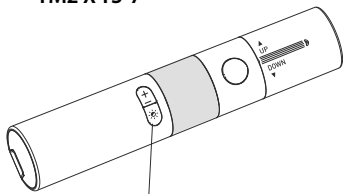

Activation/ Désactivation de la fonction solaire

ÉMETTEURS COMPATIBLES

TM2 X TT-50

Voir les instructions spécifiques

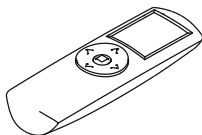

TM2 X T-1

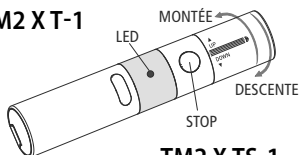

TM2 X TW-1

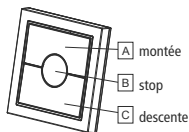

TM2 X T-7

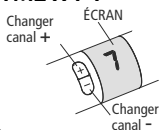

TM2 X TS-1

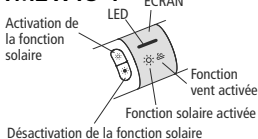

TM2 X TS-7

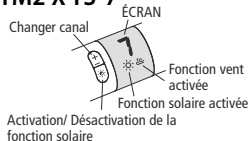

LÉGENDE DES SYMBOLES

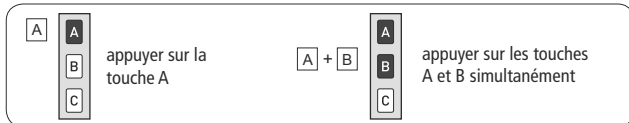
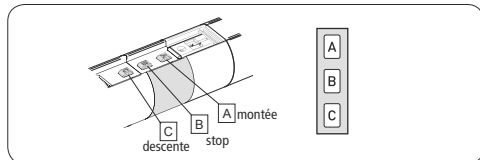
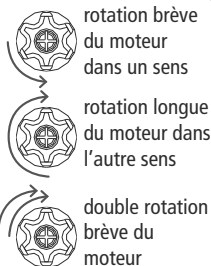
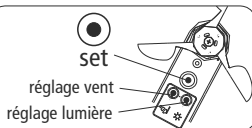
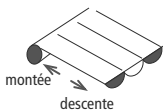

EXPLICATION DES SÉQUENCES DE COMMANDE

Les séquences se composent pour la plupart de trois étapes bien distinctes à l'issue desquelles le moteur indique par différents types de rotation si l'étape s'est achevée de façon positive ou négative. Cette section a pour objet d'expliquer les signalisations du moteur.

Les touches doivent être enfoncées comme le montre la séquence, sans laisser s'écouler plus de 4 secondes entre une étape et l'autre. Si le temps qui s'écoule dépasse les 4 secondes, la commande n'est pas acceptée et il faudra répéter la séquence.

Exemple de séquence de commande:

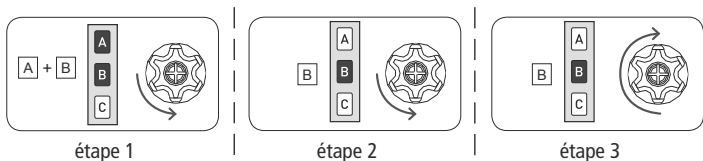

Comme le montre l'exemple, le moteur retourne à la position initiale par une seule rotation longue quand la séquence s'achève avec une issue positive. De fait, deux rotations brèves dans le même sens correspondent à une rotation longue dans le sens opposé. Le moteur retourne à la position initiale même si la séquence ne s'est pas achevée, en accomplissant dans ce cas une ou deux rotations brèves.

Exemples de séquences incomplètes:

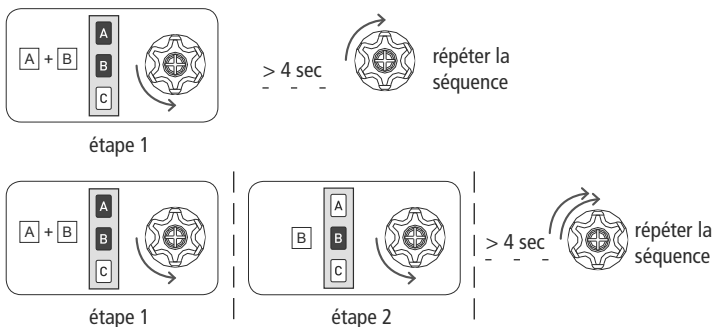

MISE EN PLACE DU CAPTEUR

TRÈS IMPORTANT!

Il est impératif de placer le capteur TM2 X SW latéralement, le plus près possible du store auquel il est associé, et éviter de le placer au-dessus ou au-dessous du store.

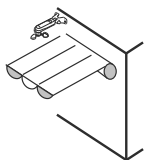

CORRECT

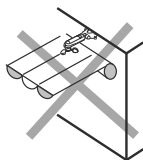

INCORRECT

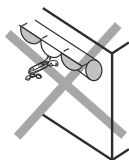

INCORRECT

ASSOCIATION DE PLUSIEURS MOTEURS AU CAPTEUR

Il est possible d'automatiser un groupe de stores motorisé en utilisant un seul capteur TM2 X SW. Pour un fonctionnement correct, il faut que les stores soient orientés dans la même direction d'exposition à la lumière et au vent. Il n'est pas conseillé d'associer plus de 5 stores au même capteur.

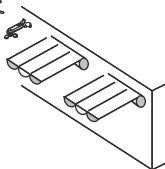

CORRECT

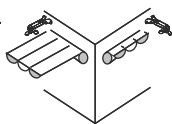

CORRECT

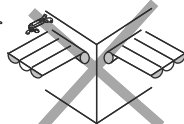

INCORRECT

FIXATION DU CAPTEUR

Le capteur TM2 X SW dispose d'un mécanisme de positionnement qui permet de le monter sur n'importe quelle surface. Pour régler l'angle du support, appuyer sur le bouton situé au niveau de l'axe de rotation (voir dessin).

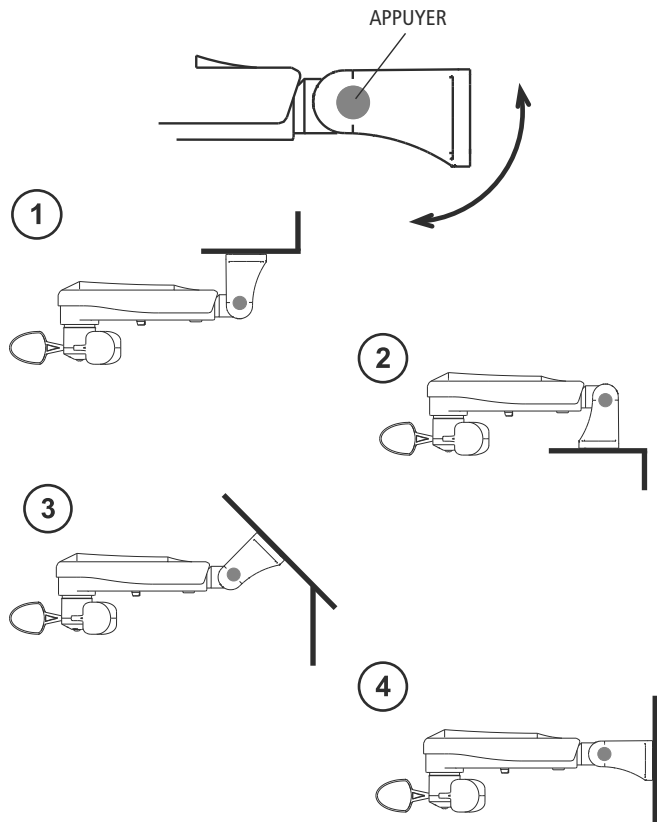

MÉMORISATION DU CAPTEUR

Pour effectuer l'association du capteur au moteur, il faut avoir mémorisé précédemment un émetteur sur le moteur. La séquence de mémorisation est la suivante:

Tn: émetteur mémorisé

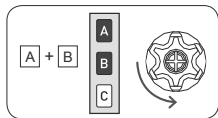

Tn

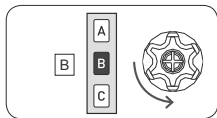

Tn



2 sec

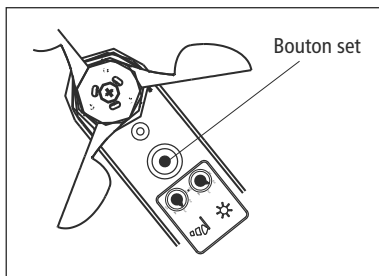

ANNULATION DU CAPTEUR

Pour annuler l'association du capteur au moteur, il faut utiliser un émetteur mémorisé sur le moteur. La séquence d'annulation est la suivante:

Tn: émetteur mémorisé

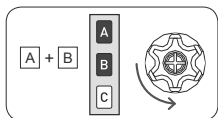

Tn

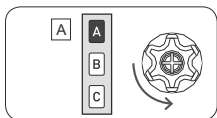

Tn



2 sec

RÉGLAGE DE LA FONCTION DU VENT

Le réglage de la valeur de seuil du vent s'accomplit à travers le potentiomètre correspondant qui se trouve dans la partie inférieure du capteur TM2 X SW, identifiée par le symbole d'une manche à vent. Le réglage peut être programmé d'une vitesse minimum de 7,5 km/h à une vitesse maximum de 45 km/h.

 Comme le montre le dessin, il est prudent de ne pas programmer le seuil au-delà de numéro 4, qui correspond à 35 km/h environ.

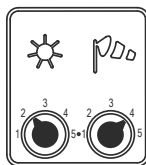
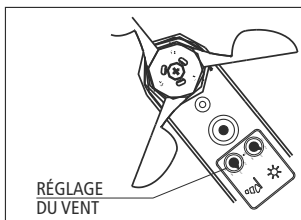

POSITION MAXI
RECOMMANDÉE (35 Km/h)

Après le déclenchement de l'alarme de vent, le moteur ordonnera au store de s'enrouler jusqu'à la position de fermeture, bloquant son actionnement par l'utilisateur jusqu'à la fin de l'alarme du vent. Pour la désactivation de l'alarme de vent, il faut que la vitesse du vent reste au-dessous du seuil programmé pendant au moins 8 minutes. Si la fonction de réouverture automatique est active, le store retournera jusqu'à la position dans laquelle il se trouvait avant l'alarme. Ce temps d'attente a été prévu pour assurer la protection du store et éviter que le moteur ne soit en mouvement constant en cas de rafales de vent sporadiques.

ACTIVATION DE LA RÉOUVERTURE AUTOMATIQUE

- uniquement avec moteurs TM2 ERY -

Le moteur est configuré à l'usine avec système de réouverture automatique (qui rouvre le store à la fin de l'alarme de vent) désactivé. Pour activer la fonction de réouverture, procéder selon la séquence suivante:

Tn: émetteur mémorisé

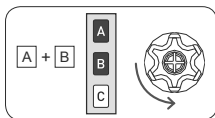

Tn

TM2 X SW

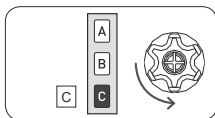

Tn

49

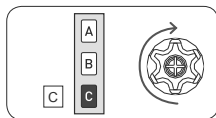

Tn (2 sec)

A4518_6H80_Rev.A

DÉSACTIVATION DE LA RÉOUVERTURE AUTOMATIQUE

- uniquement avec moteurs TM2 ERY -

Pour désactiver la fonction de réouverture automatique, accomplir à n'importe quel moment la séquence de commande suivante:

Tn: émetteur mémorisé

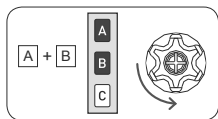

Tn

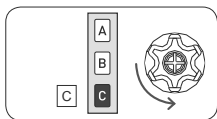

Tn

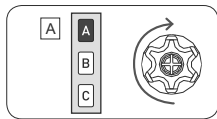

Tn (2 sec)

RÉGLAGE DE LA FONCTION LUMIÈRE

Le réglage de la valeur de seuil de lumière s'accomplit à travers le potentiomètre correspondant qui se trouve dans la partie inférieure du capteur TM2 X SW, identifiée par le symbole du soleil.



Le réglage peut être configuré d'une intensité minimum de 2,5 klux (lumière ambiante à l'aube) à une intensité maximum de 100 klux (lumière solaire à midi). Pour activer l'ouverture automatique du store, il faut que l'intensité de la lumière dépasse le seuil minimum programmé pendant 1 minute; pour activer la fermeture automatique, il faut que l'intensité de lumière reste au-dessous du seuil programmé pendant au moins 10 minutes. Ces temps d'attente ont été prévus pour éviter que le moteur ne soit en mouvement constant en cas de nuages passagers. L'ouverture et la fermeture automatiques ne fonctionnent que quand le moteur est configuré dans le mode automatique vent + lumière.

ACTIVATION DU MODE AUTOMATIQUE/MANUEL AVEC LES ÉMETTEURS SÉRIE TM2 X TS

Pour configurer le mode manuel (vent seul) ou le mode automatique (vent + lumière), il faut disposer d'un émetteur TM2 X TS-1 ou TM2 X TS-7.



active le capteur de vent et de lumière



active le capteur de vent seulement

Suivre la procédure en utilisant les touches frontales de l'émetteur:

TM2 X TS-1

Presser brièvement une des deux touches, l'écran affiche la configuration actuelle.



Activation



Désactivation

Pour changer la configuration, presser pendant au moins 3 sec. la touche correspondant à la fonction désirée; le moteur répond avec une séquence de confirmation.

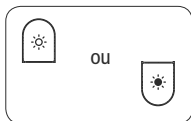

(3 sec)

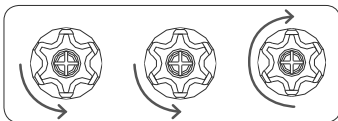

TM2 X TS-7

Presser brièvement une des deux touches, l'écran affiche la configuration actuelle.



Activation/Désactivation

Pour changer la configuration, presser à nouveau la touche pendant au moins 3 sec. ; le moteur répond avec une séquence de confirmation.

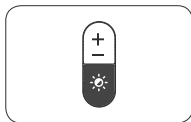

(3 sec)

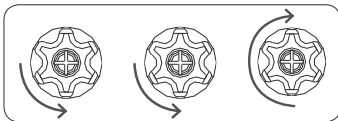

MODE DE TEST

Cette fonction est utile pour vérifier la communication correcte par radio et pour faire l'essai des fonctions vent et lumière.

Pour activer la fonction TEST, maintenir le bouton SET pressé (2 s environ) jusqu'à ce que le moteur valide la commande et porte le store à la moitié de la course d'ouverture. La fonction test reste active 3 minutes pendant lesquelles il sera possible de vérifier la configuration des seuils de vent et lumière sans qu'il soit nécessaire d'attendre les temps d'activation. Passé 3 minutes, le capteur TM2 X SW reprendra son fonctionnement normal.

FR

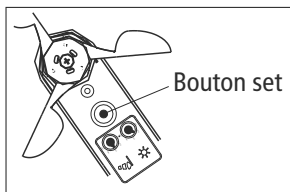

(2 sec)

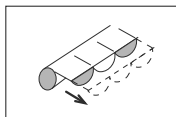

ESSAI DE LA FONCTION VENT

Pour éviter toute erreur pendant l'essai de la fonction vent, il est conseillé de mettre le moteur en mode manuel (vent seul). En actionnant le mouvement des pales de l'anémomètre quand la vitesse lue par le capteur dépasse le seuil configuré, le moteur ordonnera au store de se ré-enrouler complètement. Une fois le store enroulé, arrêter les pales de l'anémomètre; si la fonction de réouverture automatique est active, le store retournera à la moitié de sa course. Si la fonction de réouverture automatique n'est pas active, le store restera fermé.

ESSAI DE LA FONCTION LUMIÈRE

S'assurer que le moteur se trouve dans le mode automatique. Quand le capteur détecte une variation d'intensité de la lumière, il ouvre le store si l'intensité lumineuse est supérieure au seuil configuré ou le ferme si elle est inférieure à celui-ci. Il est possible de répéter ce test plusieurs fois pour établir le réglage du seuil souhaité pour l'ouverture et la fermeture automatiques selon l'intensité de la lumière.

DÉCLARATION DE CONFORMITÉ UE

Le fabricant, FAAC S.p.A. Soc. Unipersonale, déclare que le type d'équipement radio de la marque FAAC, modèle TM2 X SW est conforme à la directive 2014/53/EU, 2011/65/EU.

Le texte complet de la déclaration de conformité UE peut être lu à l'adresse Internet suivante: <http://www.faac.biz/certificates>

Bologna, 18-09-2018

CEO A. Marcellan



FR



ÍNDICE

CONEXIONES ELÉCTRICAS	55
CARACTERÍSTICAS TÉCNICAS	55
FUNCIÓN LUX	56
EMISORES COMPATIBLES	57
LEYENDA DE SÍMBOLOS	57
EXPLICACIÓN DE LAS SECUENCIAS DE MANDO	58
POSICIONAMIENTO DEL SENSOR	59
AGRUPACIÓN DE VARIOS MOTORES CON UN SENSOR	59
FIJACIÓN DEL SENSOR	60
MEMORIZACIÓN DEL SENSOR	61
BORRADO DEL SENSOR TM2 X SW EN UN MOTOR	61
REGULACIÓN DE LA FUNCIÓN VIENTO	62
ACTIVACIÓN DE LA REAPERTURA AUTOMÁTICA	62
DESACTIVACIÓN DE LA REAPERTURA AUTOMÁTICA	63
REGULACIÓN DE LA FUNCIÓN SOL	63
ACTIVACIÓN DE LA MODALIDAD AUTOMÁTICA/MANUAL CON EMISOR SERIE TM2 X TS	64
MODO TEST	65
DECLARACIÓN DE CONFORMIDAD UE	66

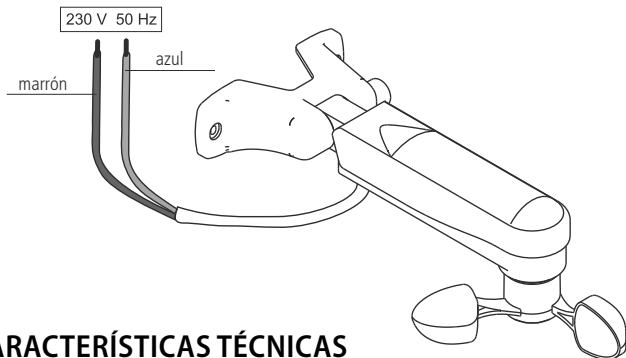
CONEXIONES ELÉCTRICAS



CARACTERÍSTICAS TÉCNICAS

	TM2 X SW		
Alimentación (V) / (Hz)	230 / 50		
Frecuencia radio (MHz)	433,92		
Regulación sensor viento (km/h)	7,5 - 45		
Regulación sensor luz (klux)	2,5 - 100		
Grado de protección	IP33		
Dimensiones (mm)	300x140xH95		
Peso (g)	365		

En base al motor/centralita al cual se encuentra asociada la TM2 X SW, la disponibilidad de algunas funciones cambia como está indicado en la siguiente tabla:

COMPATIBILIDAD	CIERRE CON ALARMA DE VIENTO	REAPERTURA AUTOMÁTICA	APERTURA Y CIERRE CON LUZ	POSICIÓN INTERMEDIA ADICIONAL	POSICIÓN "PRIVACY"
TM2 ERY	√	√	√	√	
TM2 X R Mini	√		√		

FUNCIÓN LUX

!!! MUY IMPORTANTE !!! Para utilizar la función luz en el modelo "TM2 X SW" es necesario utilizar un emisor serie TM2 X TS con la función LUX.

TM2 X TS-1

Activar función Lux

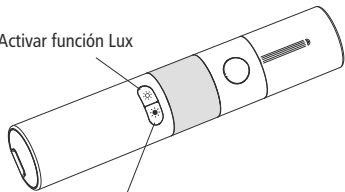

Desactivar función Lux



Sensor viento y luz activados



Sólo sensor viento activado

TM2 X TS-7

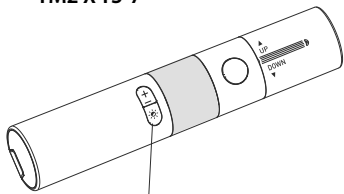

Activar/ Desactivar función Lux

EMISORES COMPATIBLES

TM2 X TT-50

Ver el libro de instrucciones del emisor

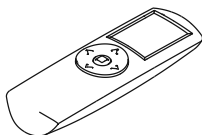

TM2 X T-1

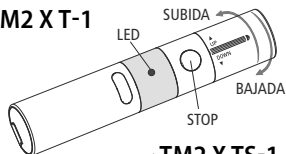

TM2 X TW-1

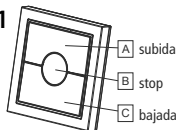

TM2 X T-7

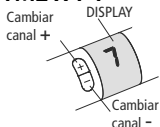

TM2 X TS-1

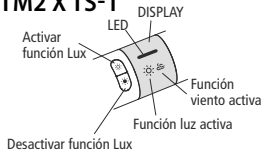

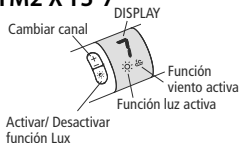

TM2 X TS-7



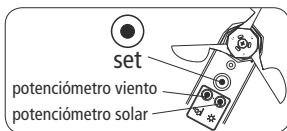
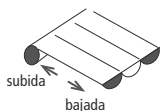



LEYENDA DE SÍMBOLOS

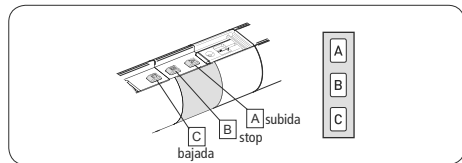

-  en los dos primeros pasos el motor realiza una breve rotación en un sentido.
-  en el tercer paso el motor realiza una rotación larga en sentido contrario a las dos anteriores.
-  si en el tercer paso el motor realiza una doble rotación en el mismo sentido, la codificación no se ha realizado correctamente. Habrá que volver a codificar la función que estábamos realizando.



			<p>Pulsar la tecla A</p>			<p>Pulsar las teclas A y B simultáneamente.</p>
--	---	---	--------------------------	---	---	---

EXPLICACIÓN DE LAS SECUENCIAS DE MANDO

La mayor parte de las secuencias de mando están compuestas por tres pasos bien diferenciados, al término de los mismos el motor realiza una señal, con diversos tipos de rotación, según el paso haya concluido en modo positivo o negativo.

El objetivo de este apartado es reconocer las indicaciones del motor.

Las teclas deben ser pulsadas tal y como se nos indica en la secuencia, sin que transcurran más de 4 segundos entre un paso y el otro. Si transcurren más de 4 segundos, la orden no será aceptada, y se deberá repetir la secuencia.

Ejemplo de secuencia de codificación:

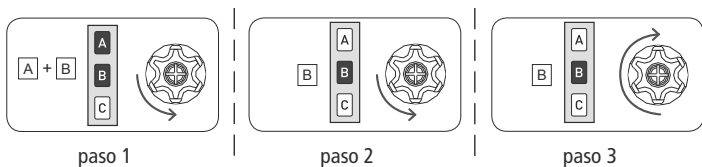

Como se ve en el ejemplo, cuando la secuencia termina de manera positiva el motor vuelve a la posición inicial mediante una rotación larga en sentido contrario a las dos anteriores. De hecho dos breves rotaciones en el mismo sentido corresponden con una rotación larga en el sentido opuesto.

El motor también vuelve a la posición inicial aunque la secuencia no haya sido correctamente completada, en este caso realizando una o dos breves rotaciones en sentido opuesto.

Ejemplos de secuencias incompletas:

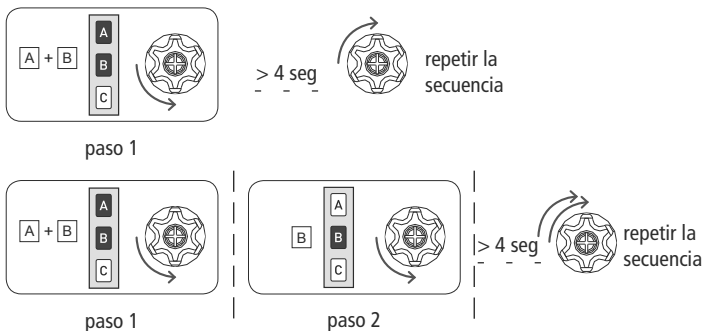

POSICIONAMIENTO DEL SENSOR

!!! MUY IMPORTANTE !!!

Es indispensable colocar el sensor TM2 X SW lo más próximo posible al toldo asociado, evitando posicionarlo en la parte superior o inferior del toldo.

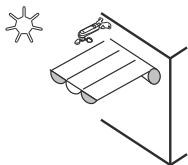

CORRECTO

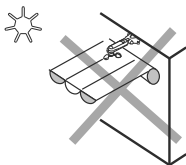

INCORRECTO

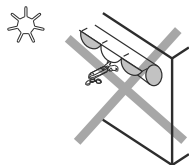

INCORRECTO

ES

AGRUPACIÓN DE VARIOS MOTORES CON UN SENSOR

Un solo sensor TM2 X SW nos permite controlar un grupo de toldos automatizados. Para un correcto funcionamiento es conveniente que los toldos a controlar estén situados en la misma orientación de sol y entrada de viento. No se recomienda controlar más de 5 toldos con un mismo sensor.

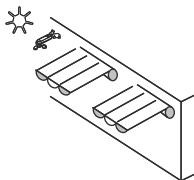

CORRECTO

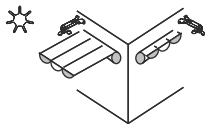

CORRECTO

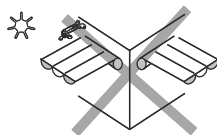

INCORRECTO

FIJACIÓN DEL SENSOR

El sensor TM2 X SW dispone de un mecanismo de posicionamiento que nos permitirá situar el sensor sobre cualquier superficie. Para regular el ángulo del soporte es necesario pulsar el botón situado junto a la articulación (véase dibujo).

ES

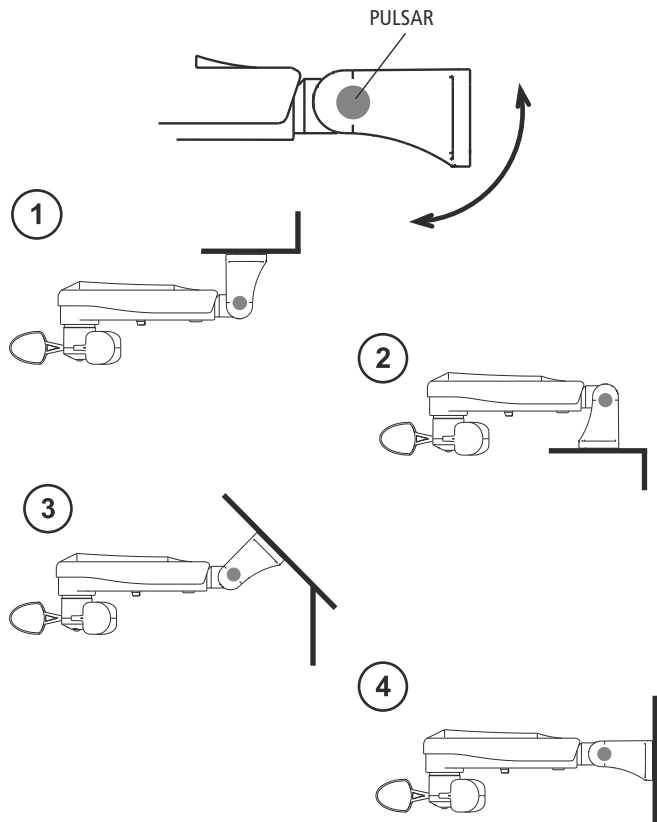

MEMORIZACIÓN DEL SENSOR

Para memorizar el sensor en el motor, es necesario haber memorizado con anterioridad un emisor en el motor. La secuencia de memorización es la siguiente:

Tn: Emisor ya memorizado

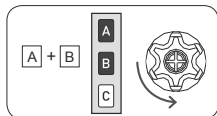

Tn

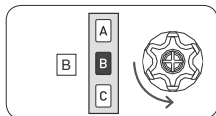

Tn



2 seg

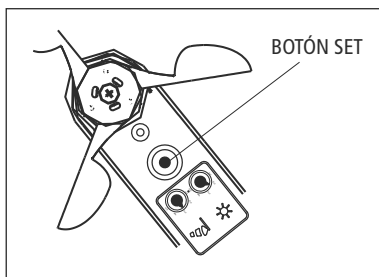

BORRADO DEL SENSOR TM2 X SW EN UN MOTOR

Para proceder a la cancelación de un sensor en un motor, es necesaria la utilización de un emisor ya memorizado en el motor. La secuencia de cancelación es la siguiente:

Tn: Emisor ya memorizado

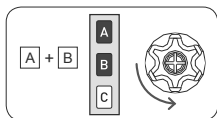

Tn

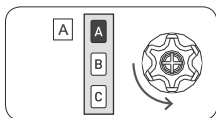

Tn



2 seg

REGULACIÓN DE LA FUNCIÓN VIENTO

La regulación del umbral de viento se realiza por medio de un potenciómetro, situado en la parte inferior del sensor TM2 X SW e identificado con el símbolo del viento. El intervalo de funcionamiento del automatismo va desde una velocidad mínima de 7,5 Km/H, hasta una velocidad máxima de 45 Km/H.



Como está especificado en el dibujo, no se recomienda situar el potenciómetro por encima del número 4, esto corresponde con unos 35 Km/h.

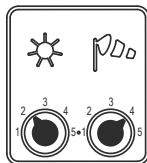
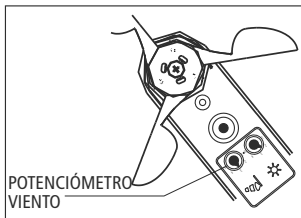

POSICIÓN MAX.
RECOMENDADA (35 Km/H)

Tras una alarma de viento el motor mandará la recogida del toldo hasta la posición del fin de carrera de cierre, bloqueando el accionamiento desde el emisor hasta que cese la alarma de viento. Para la desactivación de la alarma de viento es necesario que la velocidad del viento permanezca por debajo del valor programado por al menos 8 minutos. Una vez transcurridos estos 8 minutos, si la función de reapertura automática está activada, el motor realizará una bajada, y situará el toldo en la posición en la que se encontraba antes de la alarma de viento. Estos tiempos de espera están programados para que el motor no esté en continuo funcionamiento en los días de rachas de viento.

ACTIVACIÓN DE LA REAPERTURA AUTOMÁTICA

- sólo con motores TM2 ERY -

Con el sistema de reapertura automática el toldo se extiende apenas finaliza la alarma de viento. El motor está programado de fábrica con la función de reapertura automática desactivada. La función puede ser activada en cualquier momento con la siguiente secuencia de mando:

Tn: Emisor ya memorizado

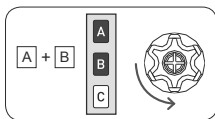

Tn

TM2 X SW

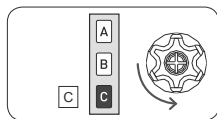

Tn

62

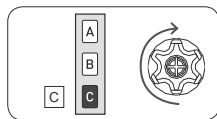

Tn (2 seg)

A4518_6H80_Rev.A

DESACTIVACIÓN DE LA REAPERTURA AUTOMÁTICA

- sólo con motores TM2 ERY -

La función de reapertura automática puede ser desactivada con la siguiente secuencia de mando:

Tn: Emisor ya memorizado

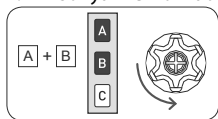

Tn

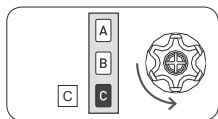

Tn

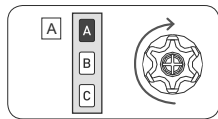

Tn (2 seg)

REGULACIÓN DE LA FUNCIÓN SOL

La regulación del umbral de sol se realiza por medio de un potenciómetro, situado en la parte inferior del sensor WinTec Lux, identificado con el símbolo del sol.

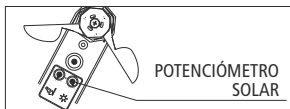

El potenciómetro nos permite la regulación entre los 2,5 Klux (luz solar al alba y ocaso) y los 100 Klux (luz al mediodía). Para activar la apertura automática del toldo es necesario que el umbral de luz solar sea superado durante al menos 1 minuto, y para la activación de la recogida automática, el nivel de luminosidad deberá estar por debajo del umbral programado durante al menos 10 minutos. Los tiempos de espera están programados para que el motor no esté en continuo funcionamiento en los días de nubes pasajeras. La apertura y el cierre automático funcionan sólo cuando el motor se encuentre en modo automático.

ACTIVACIÓN DE LA MODALIDAD AUTOMÁTICA/MANUAL CON EMISOR SERIE TM2 X TS

Para programar la modalidad manual (sólo viento), o la automática (sol y viento), es necesario el emisor TM2 X TS-1 o TM2 X TS-7.



sensor viento y luz
activados



sólo sensor viento
activado

Utilizando los botones frontales del emisor realizar lo siguiente:

TM2 X TS-1

Pulsando brevemente uno de los dos botones, el display muestra la programación actual.



Activar



Desactivar

Para cambiar la programación, es necesario pulsar durante al menos 3 segundos el botón correspondiente a la función deseada, hasta que el motor responde con una secuencia de confirmación.

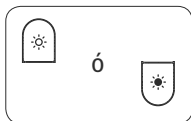

(3 seg)

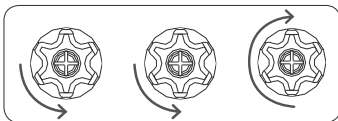

TM2 X TS-7

Pulsado brevemente el botón, el display muestra la programación actual.



Activar/ Desactivar

Para cambiar la programación, es necesario volver a pulsar el botón durante al menos 3 segundos, hasta que el motor responde con una secuencia de confirmación.

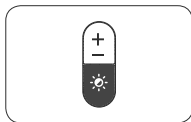

(3 seg)

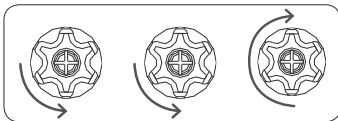

MODO TEST

Esta operación nos contrasta que la comunicación vía radio del motor con el sensor es totalmente correcta, y para efectuar la prueba de las funciones viento y luz.

Para activar la Función Test, mantendremos pulsado el botón SET (2 seg), hasta que el motor nos confirme, que ha entrado en modo test, llevando el toldo hasta una posición intermedia del recorrido del mismo. La función de test permanecerá activa durante 3 minutos durante los cuales pueden comprobarse los valores de viento y sol establecidos sin necesidad de esperar los tiempos de activación. Después de 3 minutos, el sensor vuelve a funcionar en modo normal.

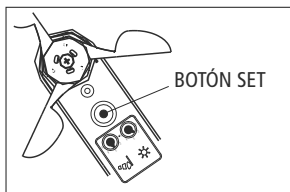

(2 seg)

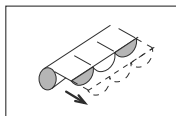

PRUEBA DE LA FUNCIÓN VIENTO

Para evitar errores durante la prueba del viento es recomendable que el motor esté en modo manual (sólo viento). Poniendo en movimiento las aspas del sensor, cuando la velocidad detectada por el sensor supere a la programada, el motor recogerá el toldo. Tras la recogida el toldo, parando las aspas del anemómetro, el toldo vuelve a mitad de recorrido si la función de reapertura automática está activada. Si la función de reapertura automática no está activa, el toldo permanecerá cerrado.

PRUEBA DE LA FUNCIÓN SOL

Nos aseguraremos que el sensor se encuentre en modo automático. Es importante que el sensor solar note la variación de luz, cuando la intensidad de la luz esté por encima del umbral establecido el motor abrirá el toldo, por el contrario recogerá el toldo cuando la intensidad de la luz esté por debajo del umbral establecido. Es posible repetir esta operación en varias ocasiones, para establecer el umbral deseado para la apertura y recogida automática en base a la intensidad de la luz.

DECLARACIÓN DE CONFORMIDAD UE

El fabricante, FAAC S.p.A. Soc. Unipersonale, declara que el tipo de equipo de radio marca FAAC modelo TM2 X SW cumple los requisitos de la directiva 2014/53/EU, 2011/65/EU.

El texto completo de la declaración de conformidad UE está disponible en la siguiente dirección de Internet: <http://www.faac.biz/certificates>

Bologna, 18-09-2018

CEO A. Marcellan





OVERZICHT

ELEKTRISCHE AANSLUITINGEN	68
TECHNISCHE KENMERKEN	68
LUX FUNCTIE	69
COMPATIBELE AFSTANDBEDIENINGEN	70
LEGENDE VAN DE SYMBOLEN	70
UITLEG VAN DE BEDIENINGSREEKS	71
STAND VD SENSOR	72
MEERDERE MOTOREN OP EEN SENSOR	72
BEVESTIGING VD SENSOR	73
SENSOR MEMORISEREN	74
SENSOR WISSEN	74
WINDFUNCTIE AFSTELLEN	75
ACTIVERING VAN DE AUTOMATISCHE HEROPENING	75
AUTOMATISCHE HEROPENING DEACTIVEREN	76
LICHTFUNCTIE AFSTELLEN	76
AUTOMATISCH/HANDMATIG MODI MET TM2 X TS AFSTANDBEDIENING ACTIVEREN	77
TESTMODUS	78
EU-CONFORMITEITSVERKLARING	79

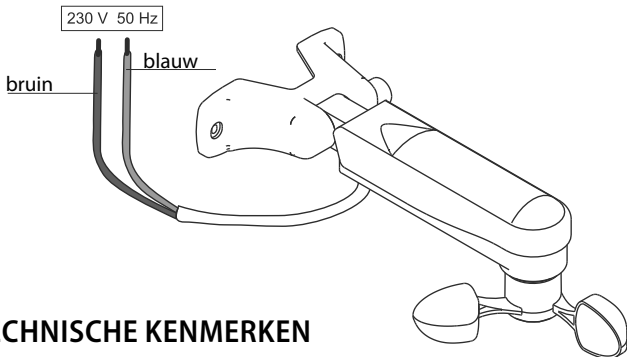
ELEKTRISCHE AANSLUITINGEN



TECHNISCHE KENMERKEN

	TM2 X SW	 
Voeding (V) / (Hz)	230 / 50	
Radiofrequentie (MHz)	433.92	
Windsensor regeling (km/h)	7.5 - 45	
Lichtsensoren regeling (klux)	2.5 - 100	
Beschermingsklasse	IP33	
Afmetingen (mm)	300x140xH95	
Gewicht (g)	365	

Afhankelijk van de motor/regeleenheid waarmee de TM2 X SW gekoppeld is, zijn sommige functies verschillend; zie tabel hieronder:

COMPATIBILITEIT	SLUITING MET WINDALARM	HEROPENING AUTOMATISCH	OPENING EN SLUITING MET LICHT*	EXTRA TUSSENSTAND*	STAND "PRIVACY"**
TM2 ERY	√	√	√	√	
TM2 X R Mini	√		√		

LUX FUNCTIE

BELANGRIJK! Om de lichtfunctie voor model "TM2 X SW" te gebruiken, heeft u een afstandsbediening van de serie TM2 X T met LUX functie nodig.

TM2 X TS-1

Activering lichtfunctie

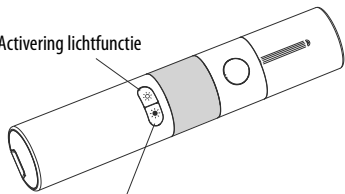

Deactivering lichtfunctie



Windsensor en lichtsensief actief



Alleen windsensief actief

TM2 X TS-7

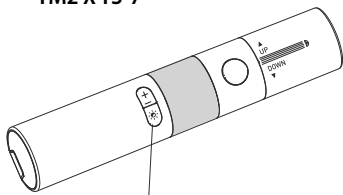

Activering/Deactivering lichtfunctie

NL

COMPATIBELE AFSTANDSBEDIENINGEN

TM2 X TT-50

U wordt verwezen naar de specifieke handleiding van de afstandsbediening

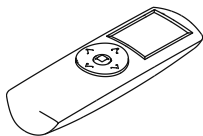

TM2 X T-1

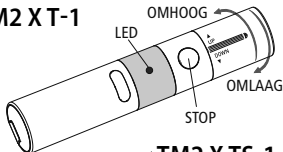

TM2 X TW-1

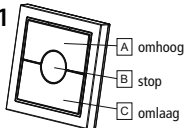

TM2 X T-7

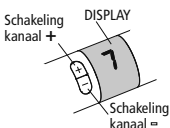

TM2 X TS-1

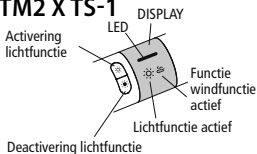

TM2 X TS-7

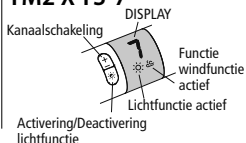

LEGENDE VAN DE SYMBOLEN

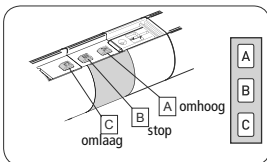
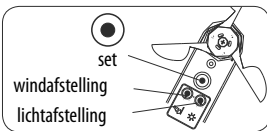
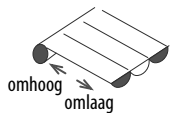

Druk op toets A

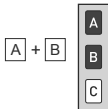

Druk op de toetsen A en B tegelijkertijd

UITLEG VAN DE BEDIENINGSREEKS

De meeste reeksen bedieningen bestaan uit drie verschillende stappen. Aan het einde hiervan, geeft de motor met verschillende soorten rotatie aan of de stap positief of negatief is afgerond. Het doel van dit paragraaf is om uitleg te geven om de signalen vanaf de motor te herkennen.

De toetsen dienen in de aangegeven volgorde te worden ingedrukt en zonder dat er meer dan 4 seconden tussen iedere stap wordt gelaten. Bij meer dan 4 seconden tussen de stappen, zal de opdracht niet uitgevoerd worden en moet de reeks herhaald worden.

Voorbeeld van bedieningsreeks:

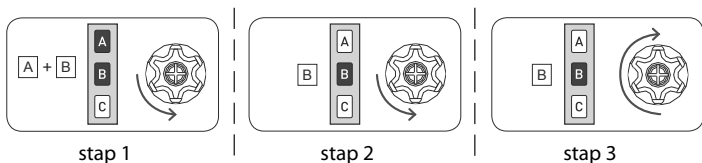

Het voorbeeld geeft aan dat wanneer de reeks positief is afgerond, de motor naar de startpositie terugkeert d.m.v. een enkele lange rotatie. In feite, twee korte rotaties in dezelfde richting gelden als een lange rotatie in de tegenovergestelde richting. De motor keert naar de startpositie terug ook wanneer de reeks niet is afgerond. In dit geval graait hij een of twee keer kort.

Voorbeelden van onvoltooide reeksen:

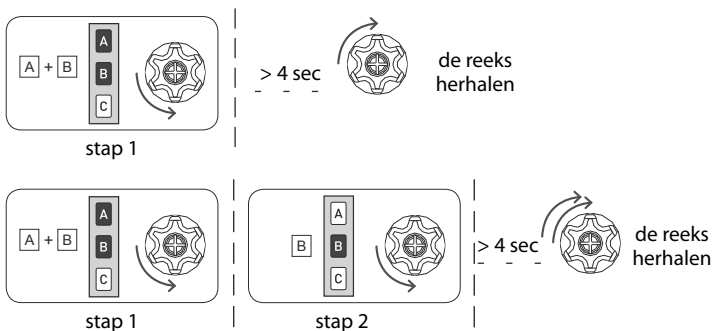

STAND VD SENSOR

BELANGRIJK!

Het is belangrijk om de sensor TM2 X SW aan de zijkant en zo dicht mogelijk bij de gekoppelde zonwering. Voorkom een afgedekte plaatsing, boven of onder de zonwering.

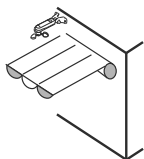

CORRECT

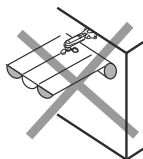

FOUT

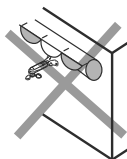

FOUT

MEERDERE MOTOREN OP EEN SENSOR

Een enkele sensor TM2 X SW kan gebruikt worden om een groep gemotoriseerde zonweringen te regelen. Voor de juiste werking, is het van belang dat de zonweringen die gekoppeld worden allemaal in dezelfde richting staan m.b.t. zonlicht en wind. Het koppelen van meer dan 5 zonweringen op één sensor wordt afgeraden.

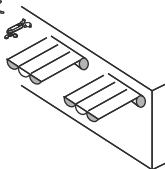

CORRECT

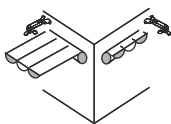

CORRECT

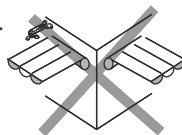

FOUT

BEVESTIGING VD SENSOR

De sensor TM2 X SW is voorzien van een bevestigingshulp waardoor deze op vrijwel elke oppervlak gemonteerd kan worden. Om de hoek van de drager af te stellen, dient u herhaaldelijk op de knop naast de draaipen (zie tekening) te drukken.

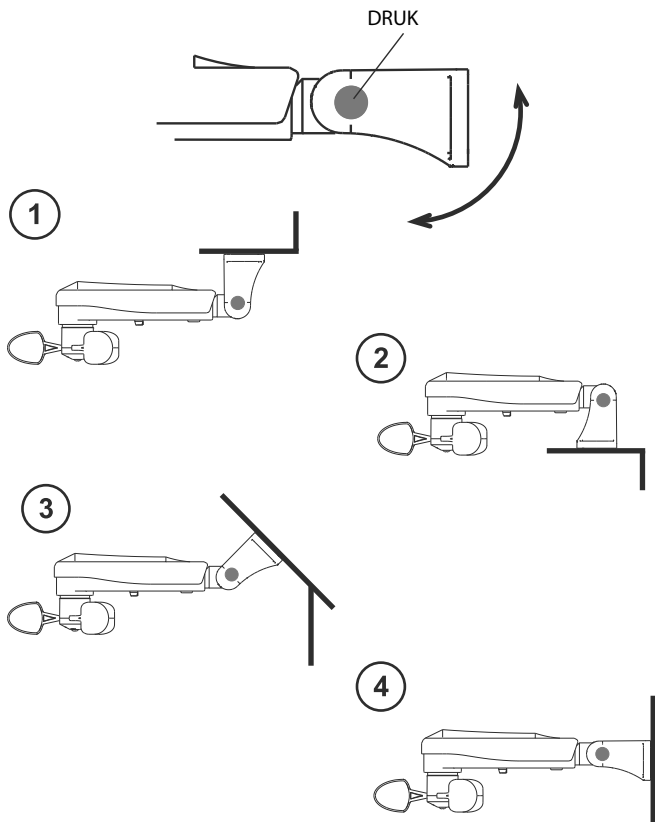

NL

SENSOR MEMORISEREN

Om de sensor aan de motor te koppelen moet eerst de afstandsbediening van de motor zijn ingesteld. De volgorde voor het memoriseren is als volgt:

Tn: Gememoriseerde afstandsbediening

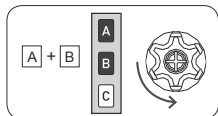

Tn

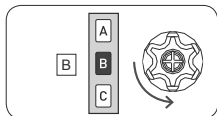

Tn



2 sec

NL

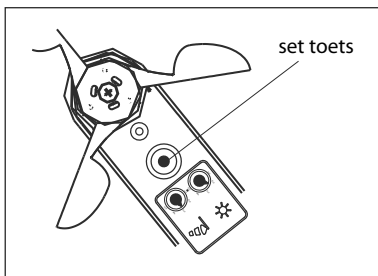

SENSOR WISSEN

Om de koppeling van de sensor met een motor te wissen moet een afstandsbediening van de motor gebruikt worden. De volgorde voor het wissen is als volgt:

Tn: Gememoriseerde afstandsbediening

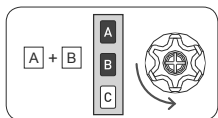

Tn

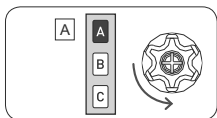

Tn



2 sec

WINDFUNCTIE AFSTELLEN

Het afstellen van de winddrempelwaarde gebeurt d.m.v. een draaiknop onderaan de sensor TM2 X SW. Deze is gekenmerkt door het windsoksymbool. Deze regeling kan vanaf de minimum windsnelheid van 7.5 km/uur, tot een maximum van 45 km/uur.



Zoals in de tekening wordt weergegeven, is het raadzaam om de drempelwaarde niet boven de 4 in te stellen, d.w.z. 35 km/uur.

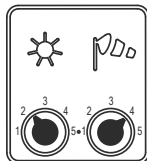
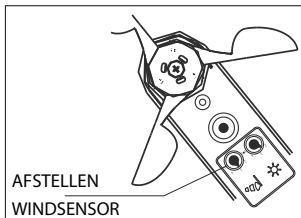

Bij een windalarm zal de motor het oprollen van de zonwering aansturen tot volledige sluiting. De bediening vanuit de gebruiker zal dan hierdoor vergrendeld worden totdat het alarm is ingetrokken. Om het windalarm uit te schakelen moet de windsnelheid minstens 8 minuten onder de drempelwaarde blijven. De automatische heropening (indien deze functie actief is) wordt aangestuurd vanuit de motor wanneer deze 8 minuten zijn verstreken. De zonwering wordt in dezelfde stand van vóór het alarm geopend. Deze wachttijd is ingesteld voor de veiligheid en bescherming van de zonwering en voorkomt dat de motor continu in beweging blijft in geval van sporadische windstoten.

ACTIVERING VAN DE AUTOMATISCHE HEROPENING

- alleen met motoren TM2 ERY -

Met de automatische heropeningsfunctie wordt de zonwering opnieuw geopend zodra het windalarm is ingetrokken.

Af fabriek is de automatische heropeningsfunctie op de motor niet ingeschakeld. U kunt deze functie op elk gewenst moment inschakelen met de volgende stappen:

Tn: Gememoriseerde afstandsbediening

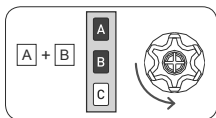

Tn

TM2 X SW

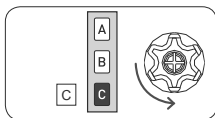

Tn

75

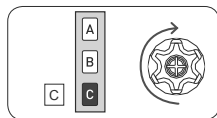

Tn (2 sec)

A4518_6H80_Rev.A

AUTOMATISCHE HEROPENING DEACTIVEREN

- alleen met motoren TM2 ERY -

U kunt deze functie op elk gewenst moment uitschakelen met de volgende stappen:

Tn: Gememoriseerde afstandsbediening

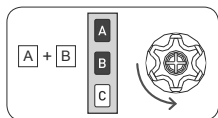

Tn

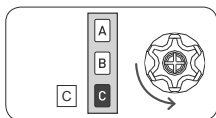

Tn

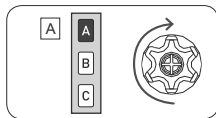

Tn (2 sec)

LICHTFUNCTIE AFSTELLEN

NL Het afstellen van de lichtdrempelwaarde gebeurt d.m.v. een draaiknop onderaan de sensor TM2 X SW. Deze is gekenmerkt door het zonsymbool.



Deze functie kan met een minimum intensiteitswaarde van 2.5 KLux (lichtintensiteit bij zonsopgang), tot een maximum waarde van 100 KLux (lichtintensiteit op het midden vd dag) worden ingesteld. Om de automatische opening van de zonwering te activeren, moet de lichtintensiteit gedurende 1 minuut de bovenste ingestelde drempelwaarde overschreiden en voor de automatische sluiting moet de lichtintensiteit voor 10 minuten beneden de onderste ingestelde drempelwaarde zakken. Deze wachttijden zijn nodig om te voorkomen dat de motor anders te vaak en snel beweegt in geval van voorbijgaande wolken. Het automatisch openen en sluiten vinden uiteraard plaats als de motor op automatisch wind + licht modus ingesteld is.

AUTOMATISCH/HANDMATIG MODI MET TM2 X TS AFSTANDBEDIENING ACTIVEREN

Om de handmatige modus in te stellen (alleen wind), of automatische modus (wind + licht), heeft u de TM2 X TS-1 of TM2 X TS-7 afstandsbediening nodig.



windsensor en
lichtsensor actief



alleen windsensor
actief

D.m.v. de toetsen aan de voorkant van de AB, voer de volgende stappen uit:

TM2 X TS-1

Een willekeurige toets even indrukken; de display gaat aan en toont de huidige instelling.



Activering



Deactivering

Om de instelling te wijzigen moet u minstens 3 sec. de gewenste functietoets ingedrukt houden totdat de motor reageert met een bevestigende beweging.

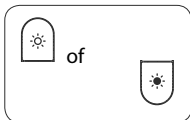

(3 sec)

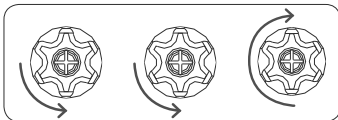

TM2 X TS-7

De toets even indrukken; de display gaat aan en toont de huidige instelling.



Activering/Deactivering

Om de instelling te wijzigen moet u minstens 3 sec. de gewenste toets ingedrukt houden totdat de motor reageert met een bevestigende beweging.

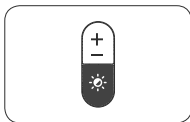

(3 sec)

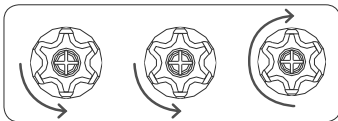

TESTMODUS

Deze functie is bedoeld om de juiste radiocommunicatie te testen en om de wind- en lichtfuncties te controleren.

Om de TEST-functie te activeren dient u de SET-toets (voor ca. 2 sec.) ingedrukt te houden totdat de motor het signaal bevestigt en de zonwering tot het midden opent. De testfunctie blijft 3 minuten actief. Gedurende deze tijd kunt u de ingestelde wind- en lichtdrempelwaarden controleren zonder dat u op de activeringstijd hoeft te wachten. Nadat de 3 minuten zijn verstreken, gaat de sensor TM2 X SW terug naar de normale werking.

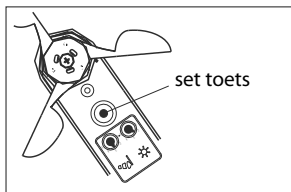

(2 sec)

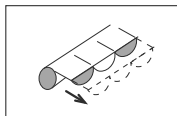

WINDFUNCTIE TESTEN

Om te voorkomen dat er tijdens het testen van de windfunctie fouten optreden, adviseren wij u de motor in de handmatige modus (alleen wind) te zetten. Laat de wieken van de windmeter draaien. Wanneer de gemeten snelheid de ingestelde drempelwaarde overschrijdt, zal de motor de zonwering volledig oprollen. Nadat de zonwering is opgerold, en de wieken van de windmeter zijn stopgezet, zal de zonwering weer tot het midden openen, indien de functie voor automatische heropening geactiveerd is. Indien de functie voor automatische heropening niet actief is, zal de zonwering gesloten blijven.

LICHTFUNCTIE TESTEN

Zorg ervoor dat de motor op automatische modus ingesteld is. Wanneer de sensor een verschil in de lichtintensiteit waarneemt, zal de zonwering worden geopend of gesloten. Wordt de drempelwaarde overschreden dan wordt deze geopend, zakt de waarde beneden de ingestelde drempelwaarde dan zal de zonwering worden gesloten. Deze handeling kan herhaald worden totdat de gewenste afstelling van de drempelwaarde voor het automatisch sluiten en openen van de zonwering op basis van de lichtintensiteit is bereikt.

EU-CONFORMITEITSVERKLARING

FAAC S.p.A. Soc. Unipersonale verklaart dat de Sensor TM2 X SW voldoet aan de toepasselijke geharmoniseerde normen van de Unie: Richtlijn 2014/53/EU, Richtlijn 2011/65/EU.

De volledige tekst van de EU-conformiteitsverklaring is beschikbaar op de volgende website: **<http://www.faac.biz/certificates>**

Bologna, 18-09-2018

CEO A. Marcellan



NL

FAAC

FAAC S.p.A. Soc. Unipersonale
Via Calari, 10 - 40069 Zola Predosa BOLOGNA - ITALY
Tel. +39 051 61724 - Fax +39 051 09 57 820
www.faac.it - www.faacgroup.com

